

Lecture 9: CNN Architectures

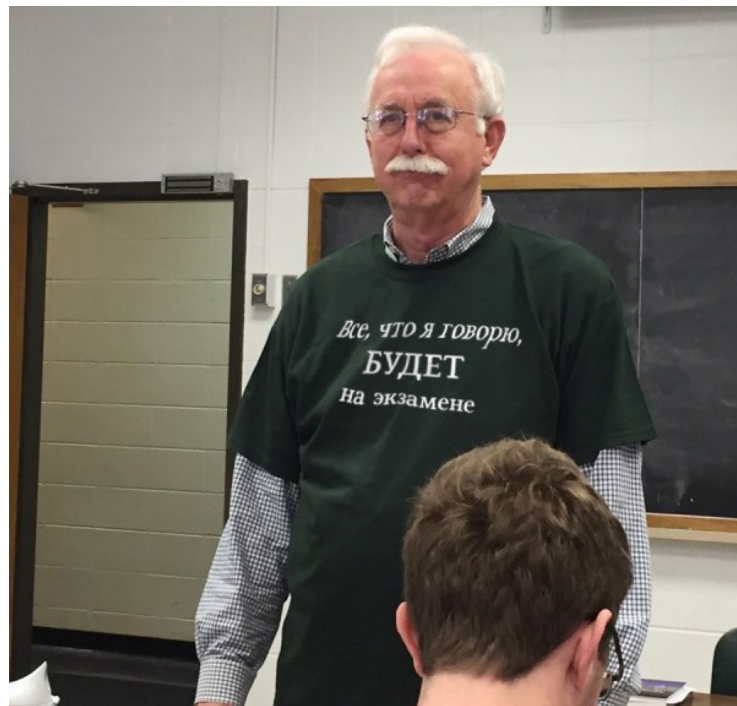

Administrative

Midterm: Take-home (1hr 40min), Tue May 12. Covers material through Lecture 10 (Thu May 7).

Midterm review session: Fri May 8 discussion section

Sample midterm has been released on Piazza.

OAE accommodations: If you have not received an email from us, please reach out to the staff mailing list ASAP.

Administrative

A3 will be released next Wed May 13, due Wed May 27

Project milestone due Mon May 18

Transfer learning

“You need a lot of a data if you want to train/use CNNs”

“You need a lot of a data if you want to train/use CNNs”

BUSTED

Transfer Learning with CNNs

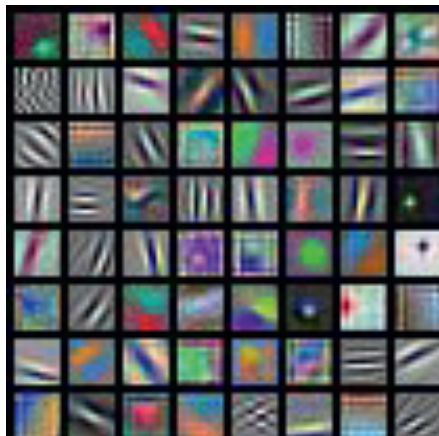
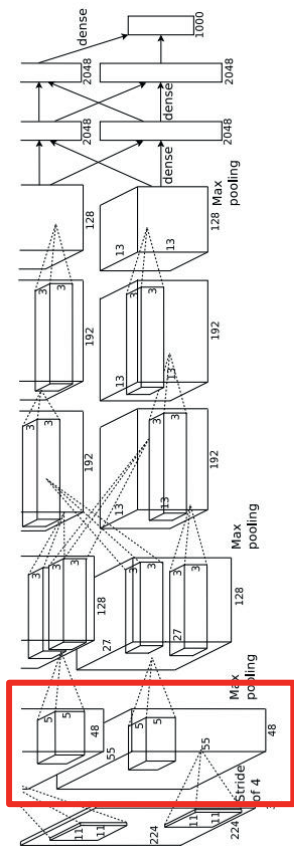

AlexNet:
64 x 3 x 11 x 11

(More on this in Lecture 13)

Transfer Learning with CNNs

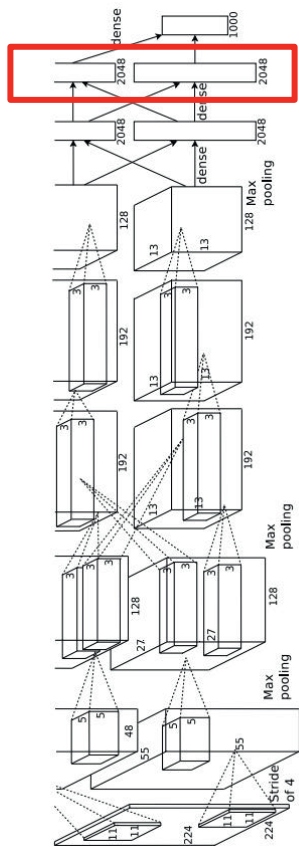

Test image L2 Nearest neighbors in feature space

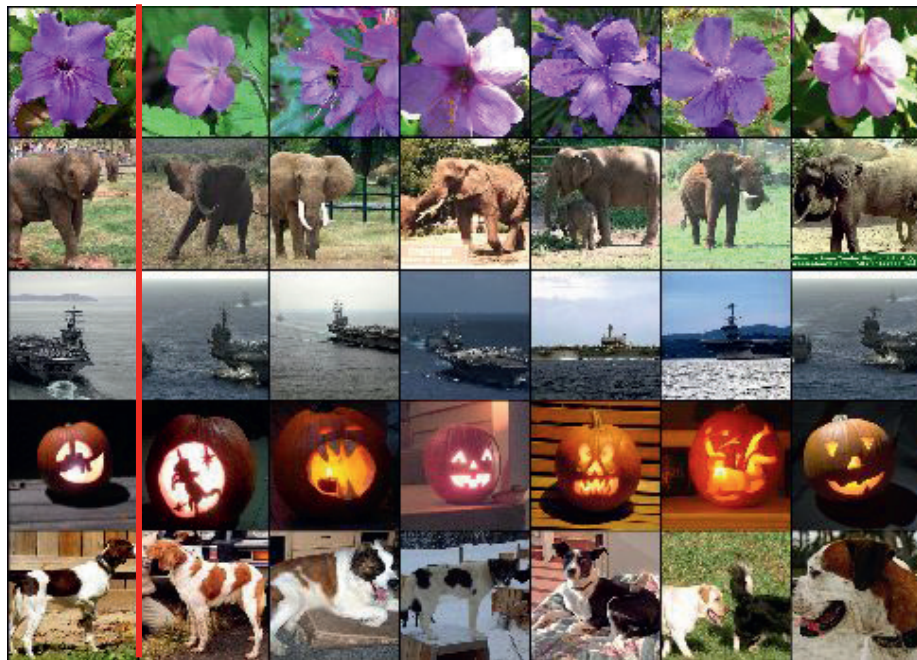

(More on this in Lecture 13)

Transfer Learning with CNNs

Donahue et al, "DeCAF: A Deep Convolutional Activation Feature for Generic Visual Recognition", ICML 2014
Razavian et al, "CNN Features Off-the-Shelf: An Astounding Baseline for Recognition", CVPR Workshops 2014

1. Train on Imagenet

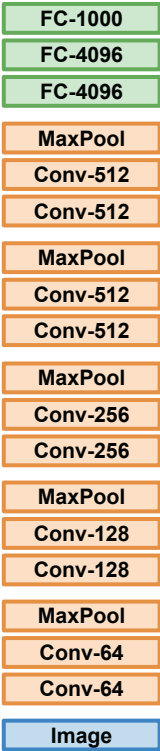

Transfer Learning with CNNs

Donahue et al, "DeCAF: A Deep Convolutional Activation Feature for Generic Visual Recognition", ICML 2014
Razavian et al, "CNN Features Off-the-Shelf: An Astounding Baseline for Recognition", CVPR Workshops 2014

1. Train on Imagenet



2. Small Dataset (C classes)

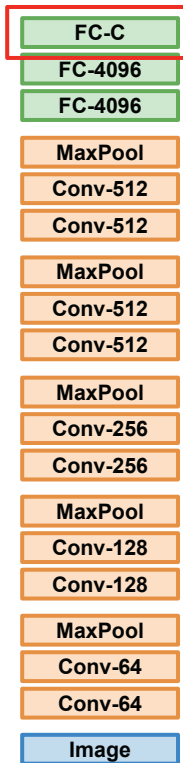

Reinitialize
this and train

Freeze these

Transfer Learning with CNNs

Donahue et al, "DeCAF: A Deep Convolutional Activation Feature for Generic Visual Recognition", ICML 2014
Razavian et al, "CNN Features Off-the-Shelf: An Astounding Baseline for Recognition", CVPR Workshops 2014

1. Train on Imagenet



2. Small Dataset (C classes)

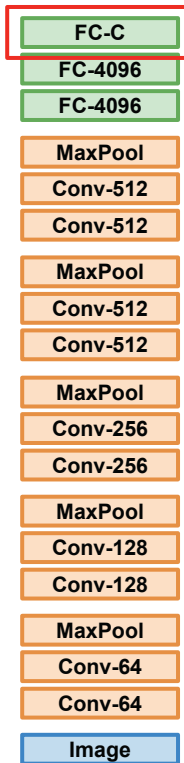

Reinitialize this and train

Freeze these

Finetuned from AlexNet

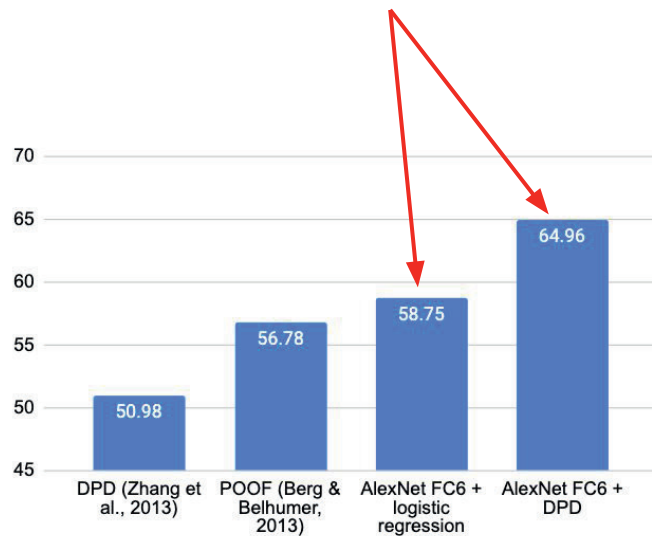

Donahue et al, "DeCAF: A Deep Convolutional Activation Feature for Generic Visual Recognition", ICML 2014

Transfer Learning with CNNs

Donahue et al, "DeCAF: A Deep Convolutional Activation Feature for Generic Visual Recognition", ICML 2014
Razavian et al, "CNN Features Off-the-Shelf: An Astounding Baseline for Recognition", CVPR Workshops 2014

1. Train on Imagenet



2. Small Dataset (C classes)

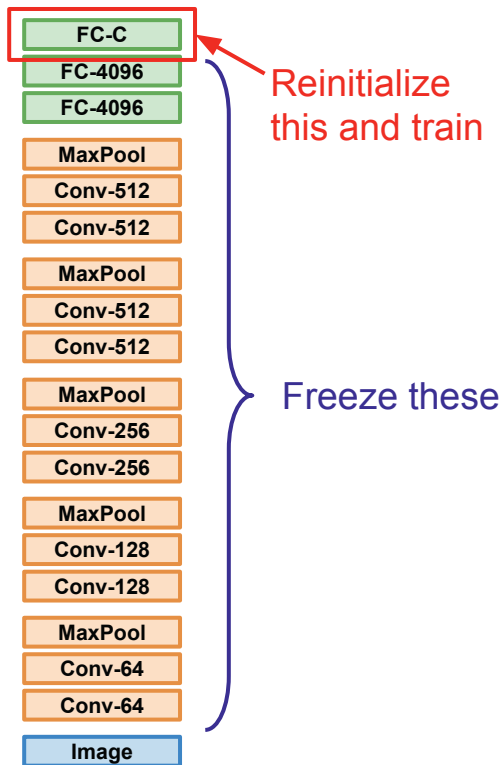

3. Bigger dataset

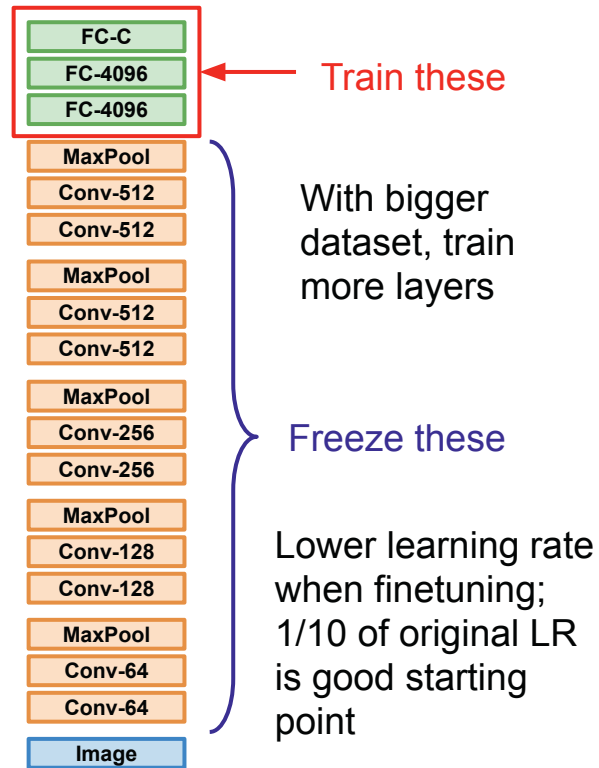



More specific

More generic

	very similar dataset	very different dataset
very little data	?	?
quite a lot of data	?	?



More specific

More generic

	very similar dataset	very different dataset
very little data	Finetune linear classifier on top layer	?
quite a lot of data	Finetune a few layers	?



More specific

More generic

	very similar dataset	very different dataset
very little data	Finetune linear classifier on top layer	You're in trouble... Try data augmentation / collect more data
quite a lot of data	Finetune a few layers	Finetune a larger number of layers

Transfer learning with CNNs is pervasive... (it's the norm, not an exception)

Object Detection (Fast R-CNN)

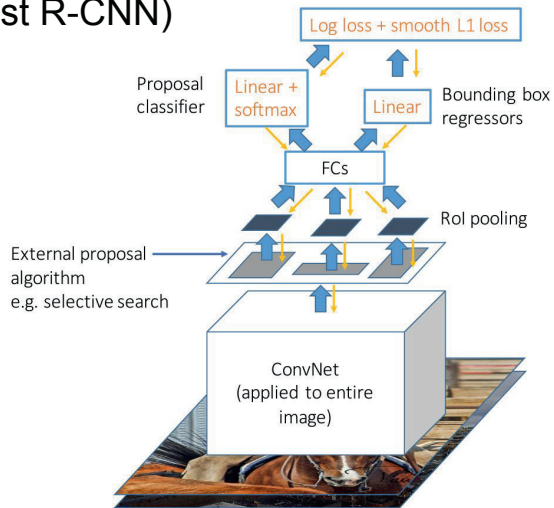

Girshick, "Fast R-CNN", ICCV 2015
Figure copyright Ross Girshick, 2015. Reproduced with permission.

Image Captioning: CNN + RNN

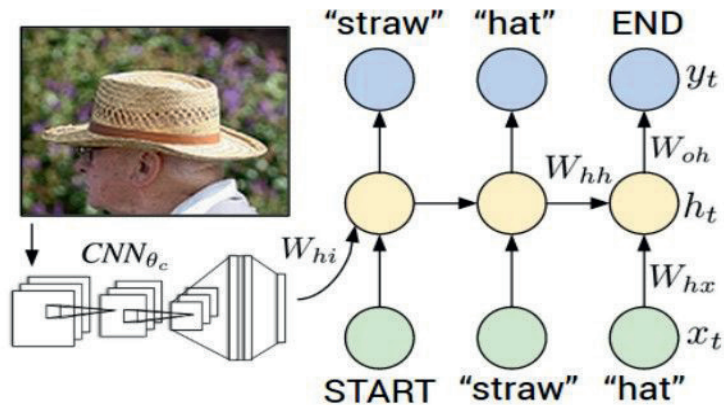

Karpathy and Fei-Fei, "Deep Visual-Semantic Alignments for Generating Image Descriptions", CVPR 2015
Figure copyright IEEE, 2015. Reproduced for educational purposes.

Transfer learning with CNNs is pervasive... (it's the norm, not an exception)

Object Detection
(Fast R-CNN)

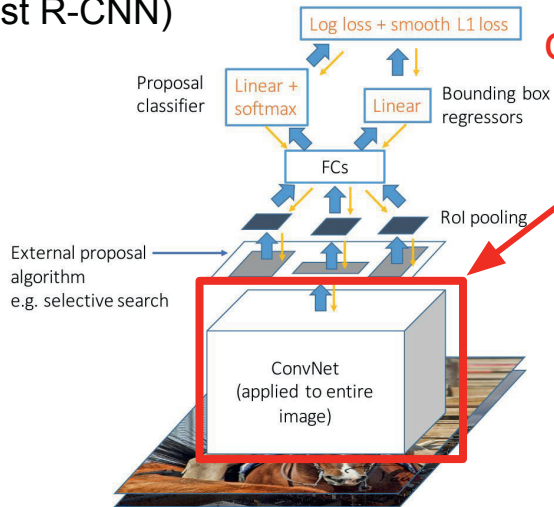

CNN pretrained
on ImageNet

Image Captioning: CNN + RNN

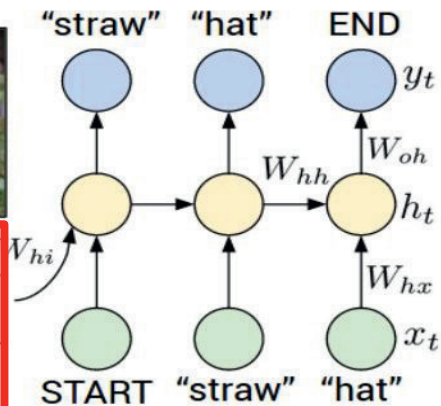
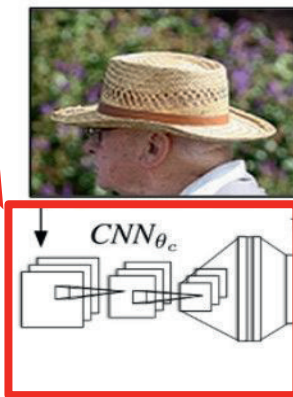

Girshick, "Fast R-CNN", ICCV 2015
Figure copyright Ross Girshick, 2015. Reproduced with permission.

Karpathy and Fei-Fei, "Deep Visual-Semantic Alignments for
Generating Image Descriptions", CVPR 2015
Figure copyright IEEE, 2015. Reproduced for educational purposes.

Transfer learning with CNNs is pervasive... (it's the norm, not an exception)

Object Detection
(Fast R-CNN)

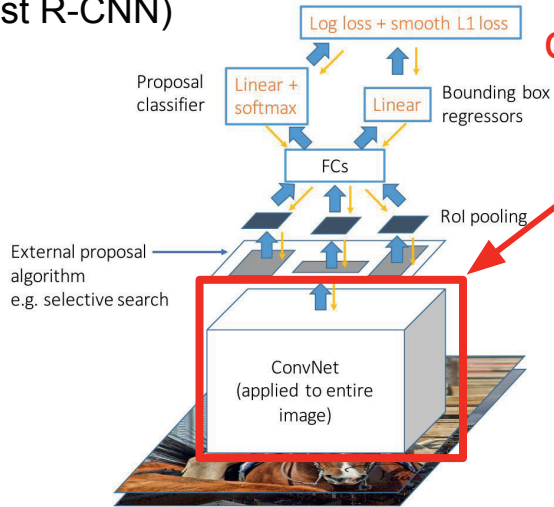

CNN pretrained
on ImageNet

Image Captioning: CNN + RNN

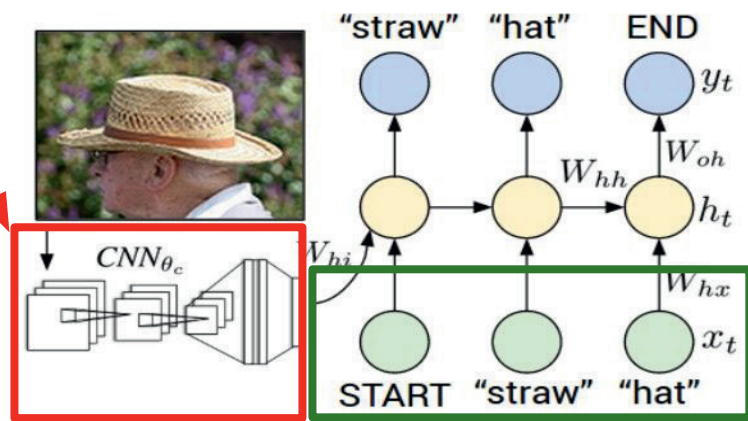

Word vectors pretrained
with word2vec

Karpathy and Fei-Fei, "Deep Visual-Semantic Alignments for
Generating Image Descriptions", CVPR 2015
Figure copyright IEEE, 2015. Reproduced for educational purposes.

Girshick, "Fast R-CNN", ICCV 2015
Figure copyright Ross Girshick, 2015. Reproduced with permission.

Transfer learning with CNNs is pervasive... (it's the norm, not an exception)

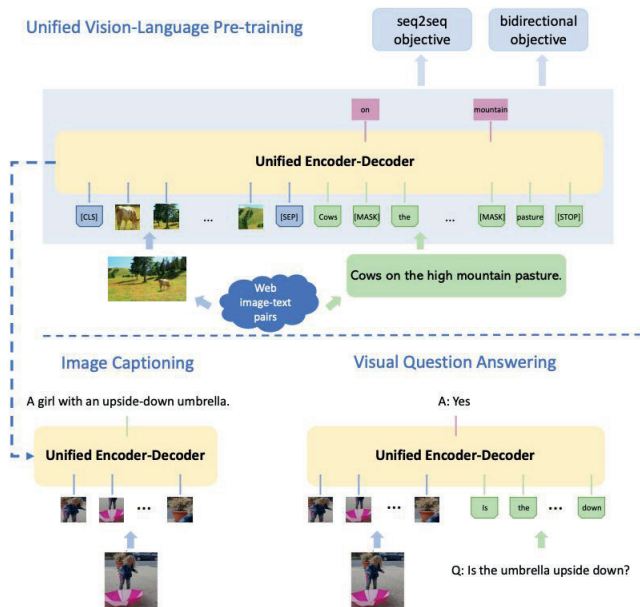

Zhou et al, "Unified Vision-Language Pre-Training for Image Captioning and VQA" CVPR 2020
Figure copyright Luwei Zhou, 2020. Reproduced with permission.

1. Train CNN on **ImageNet**
2. Fine-Tune (1) for object detection on **Visual Genome**
3. Train **BERT** language model on lots of text
4. Combine(2) and (3), train for joint image / language modeling
5. Fine-tune (4) for image captioning, visual question answering, etc.

Krishna et al, "Visual genome: Connecting language and vision using crowdsourced dense image annotations" IJCV 2017
Devlin et al. "BERT: Pre-training of Deep Bidirectional Transformers for Language Understanding" ArXiv 2018

Transfer learning with CNNs is pervasive...

But recent results show it might not always be necessary!

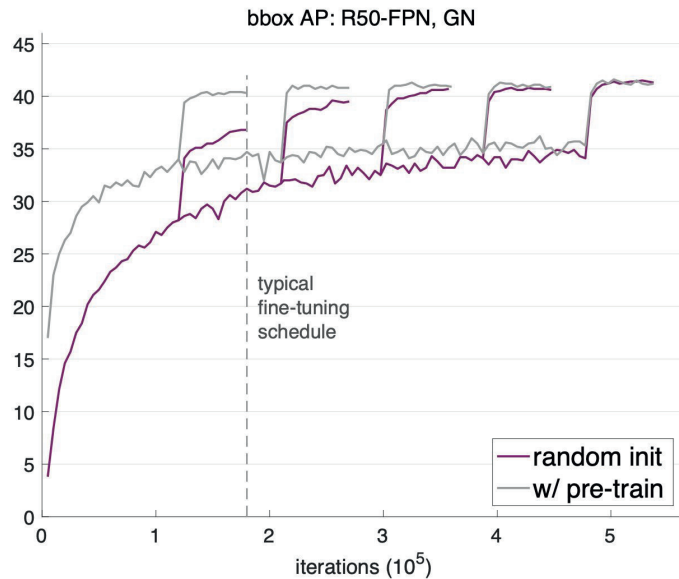

Training from scratch can work just as well as training from a pretrained ImageNet model for object detection

But it takes 2-3x as long to train.

They also find that collecting more data is better than finetuning on a related task

He et al, "Rethinking ImageNet Pre-training", ICCV 2019
Figure copyright Kaiming He, 2019. Reproduced with permission.

Takeaway for your projects and beyond:

Transfer learning be like



Source: AI & Deep Learning Memes For Back-propagated Poets

Takeaway for your projects and beyond:

Have some dataset of interest but it has $< \sim 10k$ images?

1. Find a very large dataset that has similar data, train a big ConvNet there (or take pretrained models)
2. Transfer learn to your dataset

Deep learning frameworks provide a “Model Zoo” of pretrained models so you don’t need to train your own

TensorFlow: <https://github.com/tensorflow/models>

PyTorch: <https://github.com/pytorch/vision>

CNN Architectures

Review: LeNet-5

[LeCun et al., 1998]

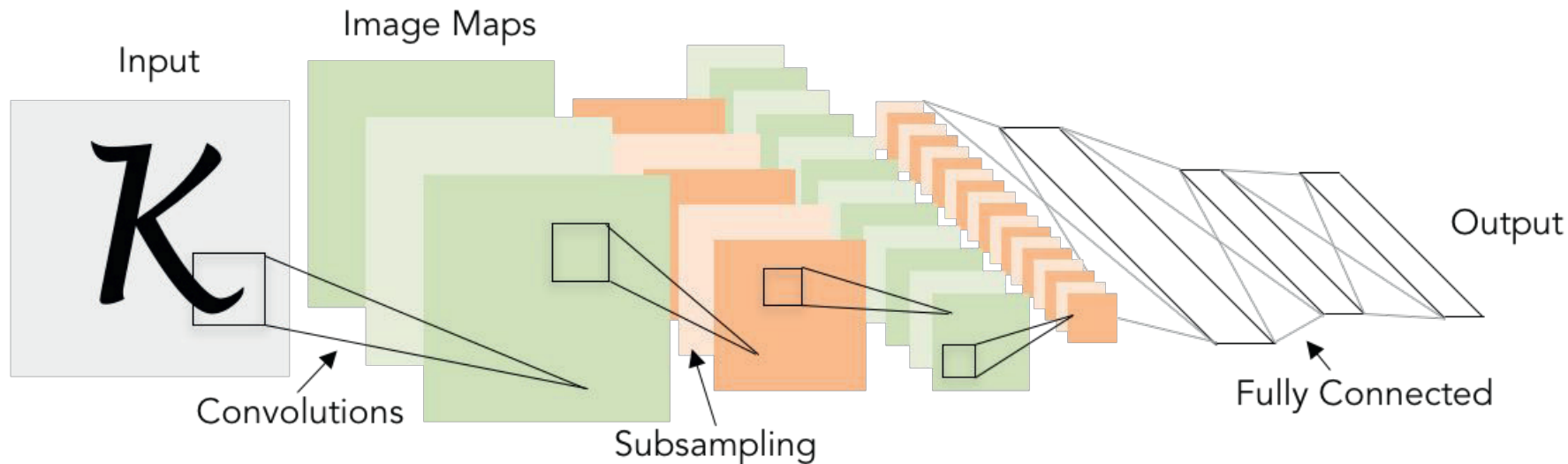

Conv filters were 5x5, applied at stride 1

Subsampling (Pooling) layers were 2x2 applied at stride 2

i.e. architecture is [CONV-POOL-CONV-POOL-FC-FC]

Review: Convolution

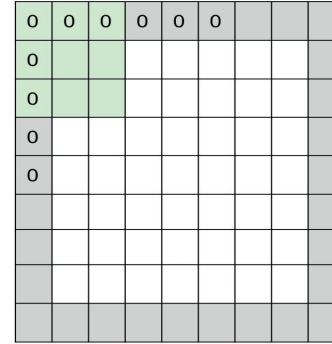
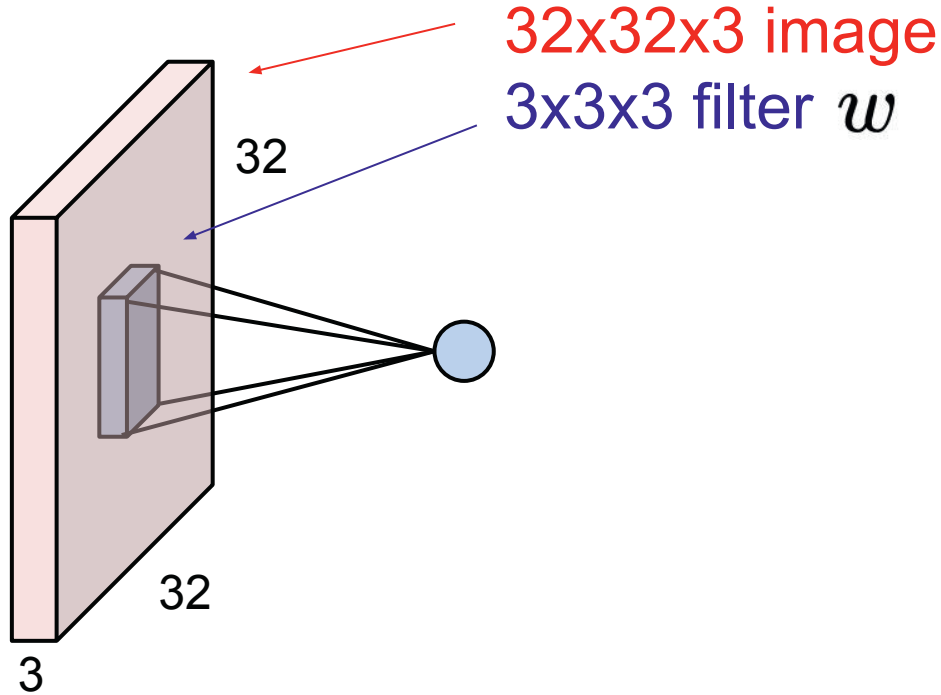

Padding:
Preserve
input spatial
dimensions in
output activations

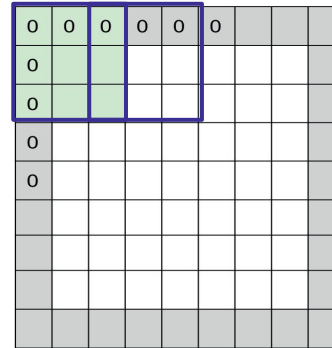

Stride:
Downsample
output activations

Review: Convolution

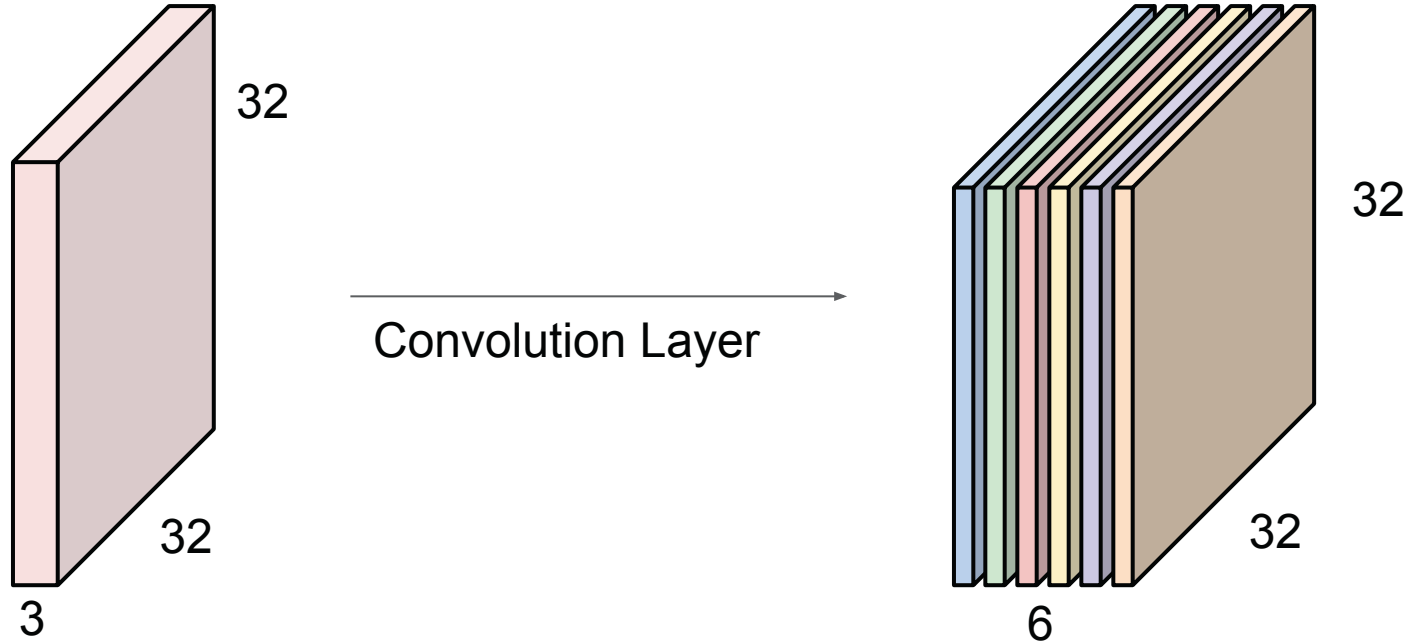

Each conv filter outputs a "slice" in the activation

Review: Pooling

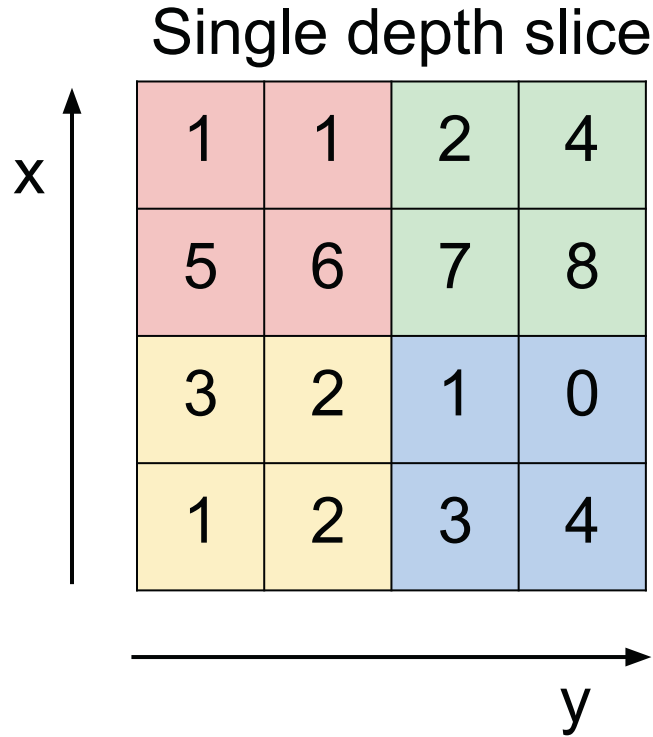

max pool with 2x2 filters
and stride 2

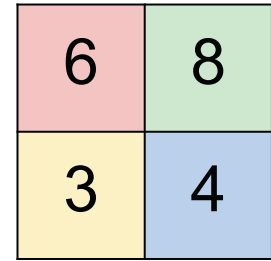

Today: CNN Architectures

Case Studies

- AlexNet
- VGG
- GoogLeNet
- ResNet

Also....

- SENet
- Wide ResNet
- ResNeXT
- DenseNet
- MobileNets
- NASNet
- EfficientNet

ImageNet Large Scale Visual Recognition Challenge (ILSVRC) winners

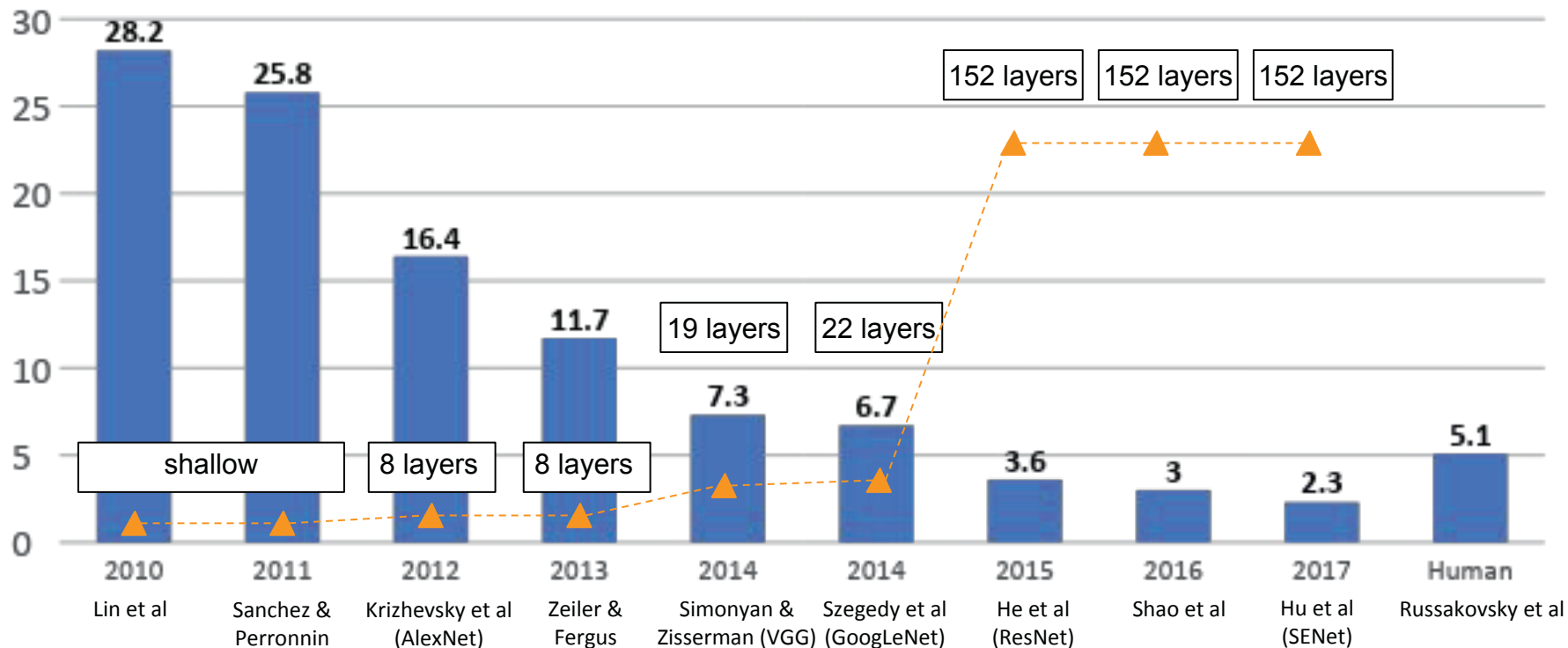

ImageNet Large Scale Visual Recognition Challenge (ILSVRC) winners

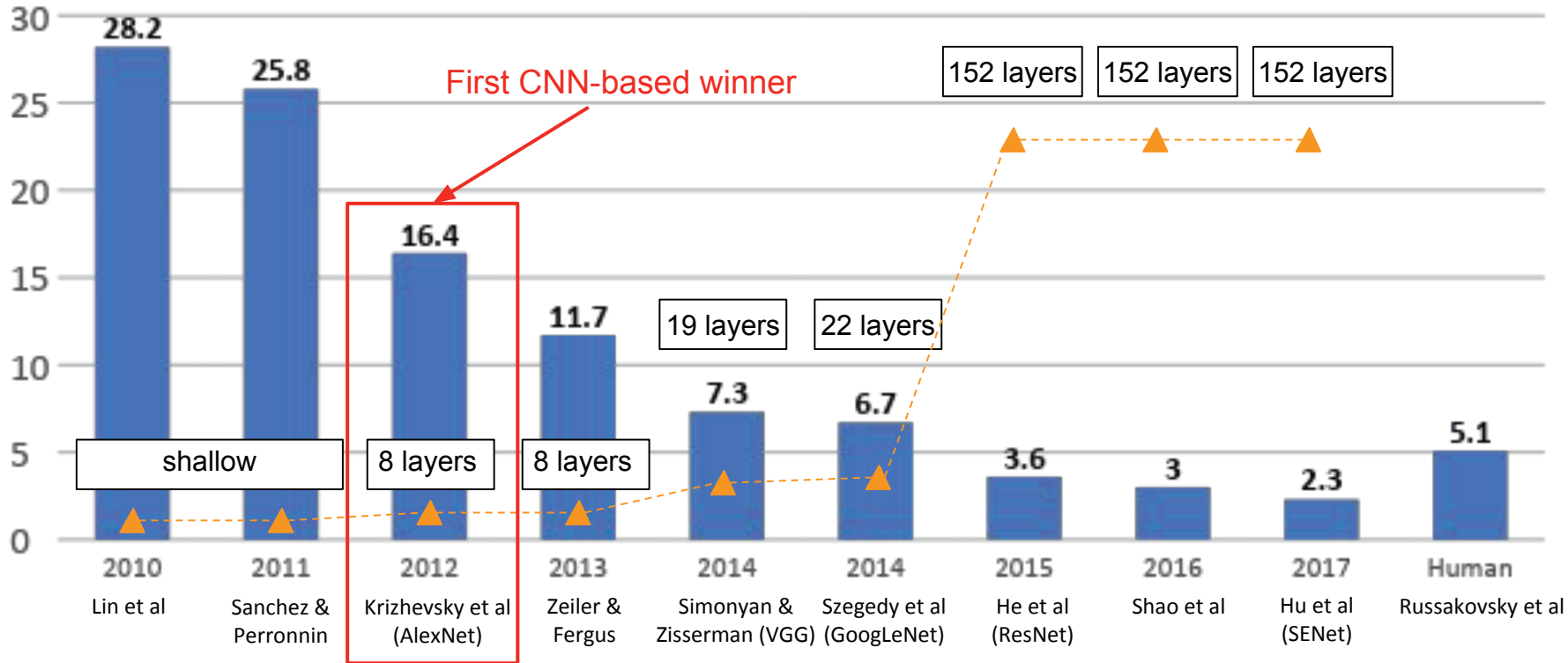

Case Study: AlexNet

[Krizhevsky et al. 2012]

Architecture:

CONV1

MAX POOL1

NORM1

CONV2

MAX POOL2

NORM2

CONV3

CONV4

CONV5

Max POOL3

FC6

FC7

FC8

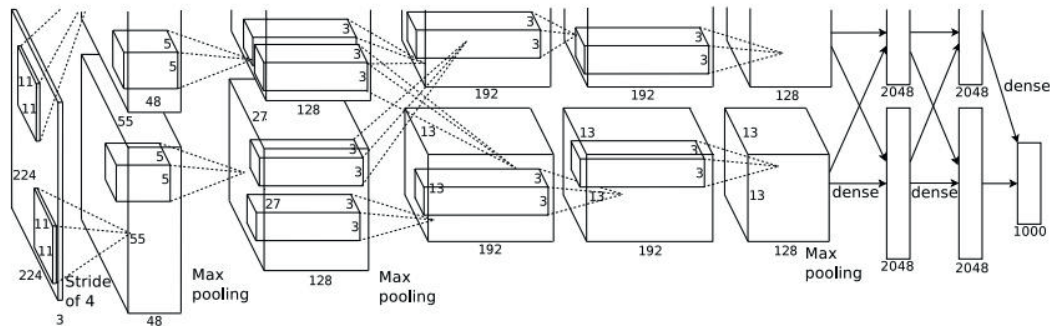
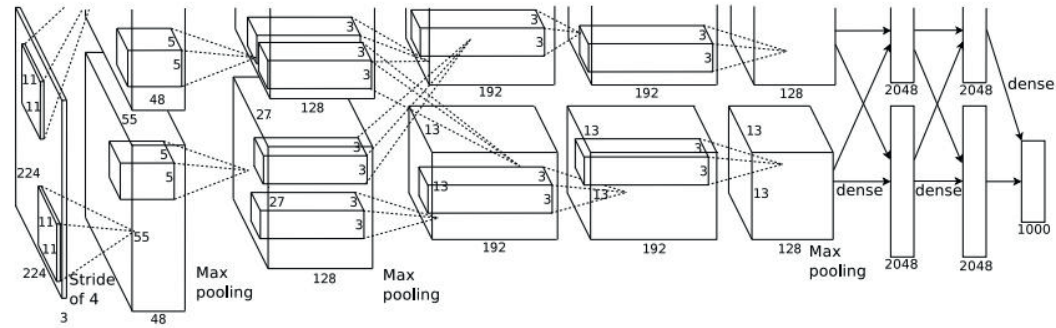

Figure copyright Alex Krizhevsky, Ilya Sutskever, and Geoffrey Hinton, 2012. Reproduced with permission.

Case Study: AlexNet

[Krizhevsky et al. 2012]



Input: 227x227x3 images

First layer (CONV1): 96 11x11 filters applied at stride 4

=>

Q: what is the output volume size? Hint: $(227-11)/4+1 = 55$

$$W' = (W - F + 2P) / S + 1$$

Figure copyright Alex Krizhevsky, Ilya Sutskever, and Geoffrey Hinton, 2012. Reproduced with permission.

Case Study: AlexNet

[Krizhevsky et al. 2012]

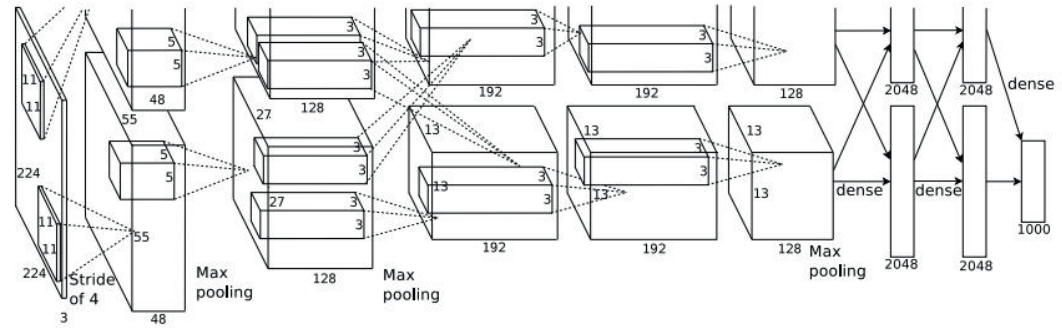

Input: 227x227x3 images

First layer (CONV1): 96 11x11 filters applied at stride 4

=>

Output volume **[55x55x96]**

$$W' = (W - F + 2P) / S + 1$$

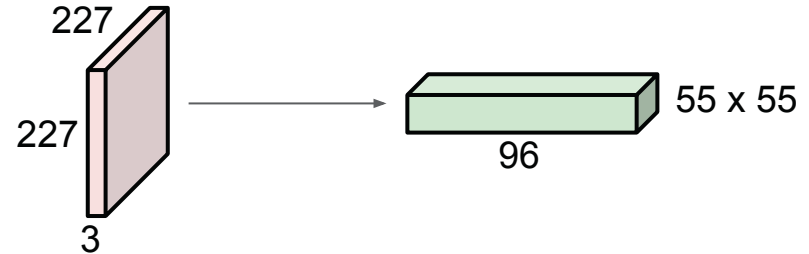
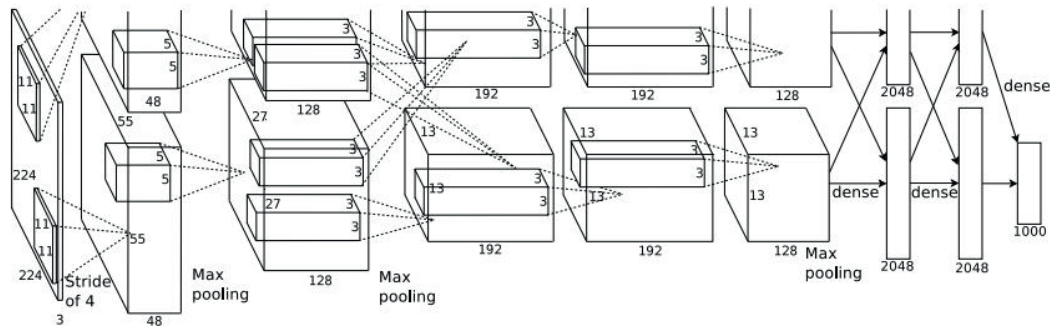

Figure copyright Alex Krizhevsky, Ilya Sutskever, and Geoffrey Hinton, 2012. Reproduced with permission.

Case Study: AlexNet

[Krizhevsky et al. 2012]



Input: 227x227x3 images

First layer (CONV1): 96 11x11 filters applied at stride 4

=>

Output volume **[55x55x96]**

Q: What is the total number of parameters in this layer?

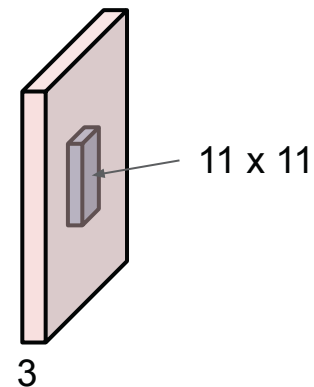
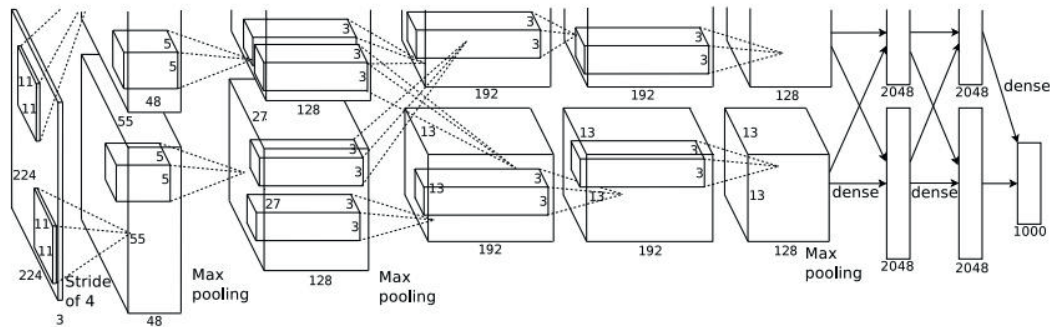

Figure copyright Alex Krizhevsky, Ilya Sutskever, and Geoffrey Hinton, 2012. Reproduced with permission.

Case Study: AlexNet

[Krizhevsky et al. 2012]



Input: 227x227x3 images

First layer (CONV1): 96 11x11 filters applied at stride 4

=>

Output volume **[55x55x96]**

Parameters: $(11*11*3)*96 = \mathbf{35K}$

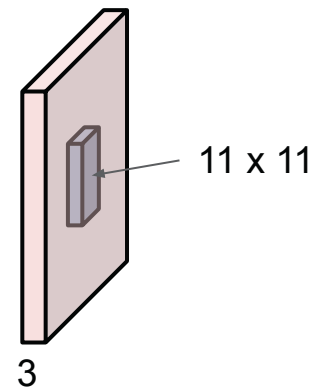
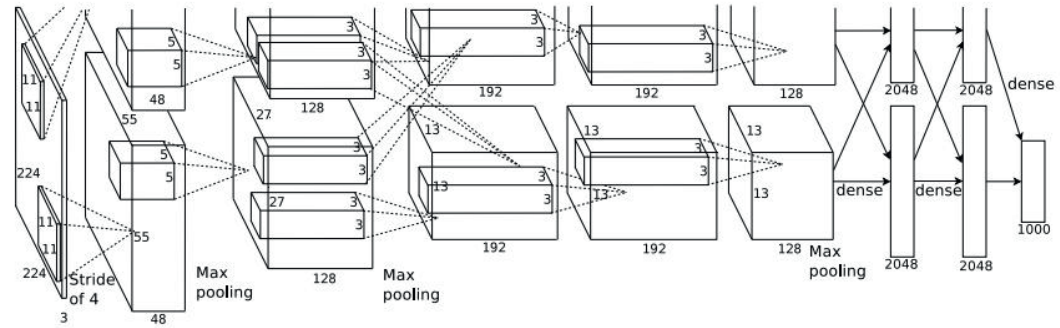

Figure copyright Alex Krizhevsky, Ilya Sutskever, and Geoffrey Hinton, 2012. Reproduced with permission.

Case Study: AlexNet

[Krizhevsky et al. 2012]



Input: 227x227x3 images

After CONV1: 55x55x96

Second layer (POOL1): 3x3 filters applied at stride 2

Q: what is the output volume size? Hint: $(55-3)/2+1 = 27$

$$W' = (W - F + 2P) / S + 1$$

Figure copyright Alex Krizhevsky, Ilya Sutskever, and Geoffrey Hinton, 2012. Reproduced with permission.

Case Study: AlexNet

[Krizhevsky et al. 2012]

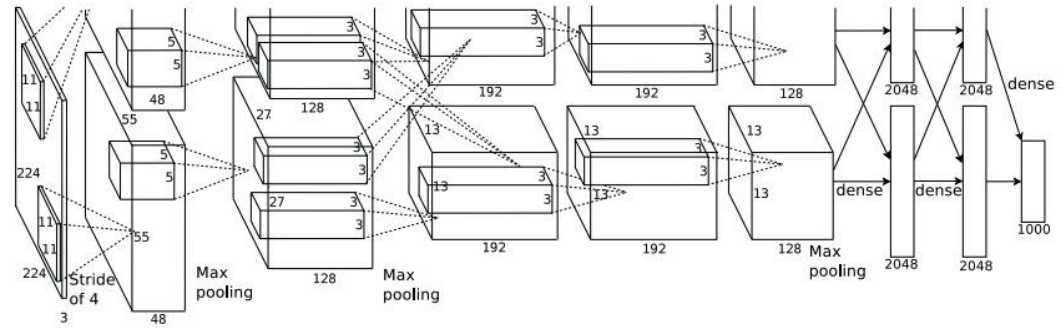

Input: 227x227x3 images

After CONV1: 55x55x96

Second layer (POOL1): 3x3 filters applied at stride 2

Output volume: 27x27x96

Q: what is the number of parameters in this layer?

$$W' = (W - F + 2P) / S + 1$$

Figure copyright Alex Krizhevsky, Ilya Sutskever, and Geoffrey Hinton, 2012. Reproduced with permission.

Case Study: AlexNet

[Krizhevsky et al. 2012]

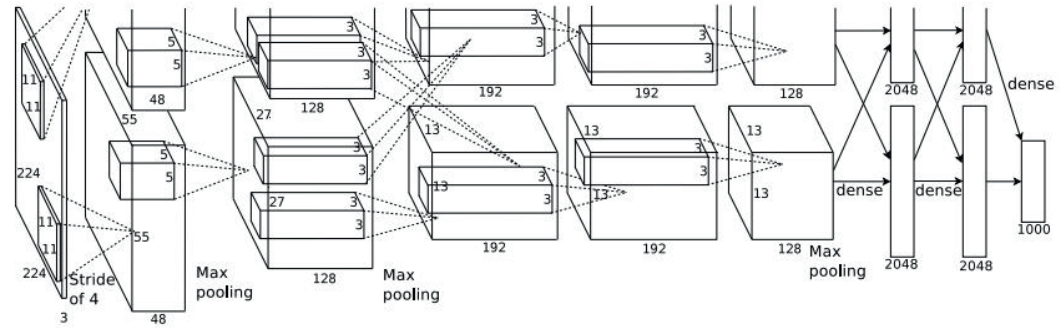

Input: 227x227x3 images

After CONV1: 55x55x96

Second layer (POOL1): 3x3 filters applied at stride 2

Output volume: 27x27x96

Parameters: 0!

Figure copyright Alex Krizhevsky, Ilya Sutskever, and Geoffrey Hinton, 2012. Reproduced with permission.

Case Study: AlexNet

[Krizhevsky et al. 2012]

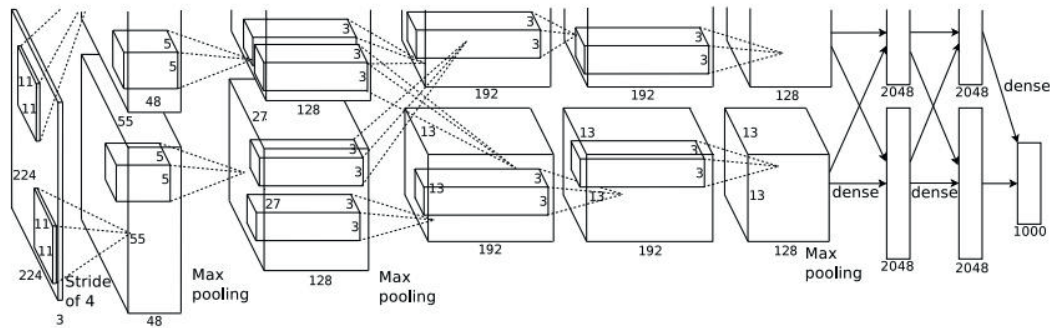

Input: 227x227x3 images

After CONV1: 55x55x96

After POOL1: 27x27x96

...

Figure copyright Alex Krizhevsky, Ilya Sutskever, and Geoffrey Hinton, 2012. Reproduced with permission.

Case Study: AlexNet

[Krizhevsky et al. 2012]

Full (simplified) AlexNet architecture:

[227x227x3] INPUT

[55x55x96] **CONV1**: 96 11x11 filters at stride 4, pad 0

[27x27x96] **MAX POOL1**: 3x3 filters at stride 2

[27x27x96] **NORM1**: Normalization layer

[27x27x256] **CONV2**: 256 5x5 filters at stride 1, pad 2

[13x13x256] **MAX POOL2**: 3x3 filters at stride 2

[13x13x256] **NORM2**: Normalization layer

[13x13x384] **CONV3**: 384 3x3 filters at stride 1, pad 1

[13x13x384] **CONV4**: 384 3x3 filters at stride 1, pad 1

[13x13x256] **CONV5**: 256 3x3 filters at stride 1, pad 1

[6x6x256] **MAX POOL3**: 3x3 filters at stride 2

[4096] **FC6**: 4096 neurons

[4096] **FC7**: 4096 neurons

[1000] **FC8**: 1000 neurons (class scores)

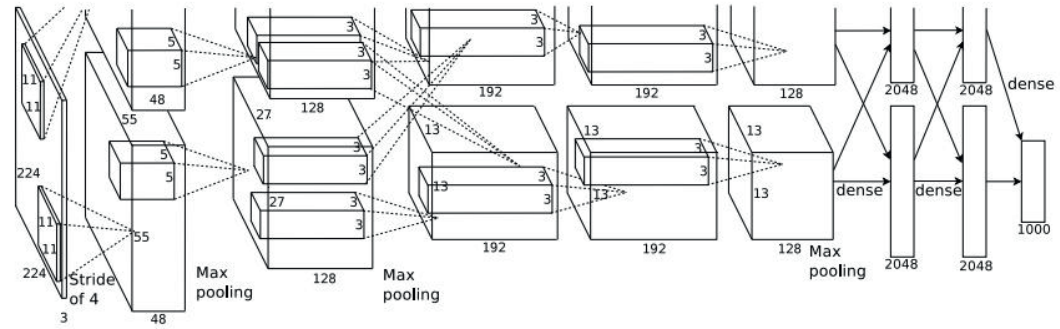

Figure copyright Alex Krizhevsky, Ilya Sutskever, and Geoffrey Hinton, 2012. Reproduced with permission.

Case Study: AlexNet

[Krizhevsky et al. 2012]

Full (simplified) AlexNet architecture:

[227x227x3] INPUT

[55x55x96] **CONV1**: 96 11x11 filters at stride 4, pad 0

[27x27x96] **MAX POOL1**: 3x3 filters at stride 2

[27x27x96] **NORM1**: Normalization layer

[27x27x256] **CONV2**: 256 5x5 filters at stride 1, pad 2

[13x13x256] **MAX POOL2**: 3x3 filters at stride 2

[13x13x256] **NORM2**: Normalization layer

[13x13x384] **CONV3**: 384 3x3 filters at stride 1, pad 1

[13x13x384] **CONV4**: 384 3x3 filters at stride 1, pad 1

[13x13x256] **CONV5**: 256 3x3 filters at stride 1, pad 1

[6x6x256] **MAX POOL3**: 3x3 filters at stride 2

[4096] **FC6**: 4096 neurons

[4096] **FC7**: 4096 neurons

[1000] **FC8**: 1000 neurons (class scores)

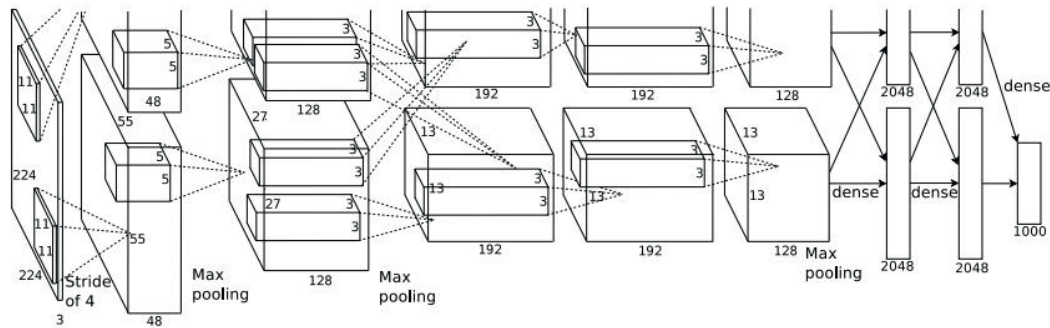

Details/Retrospectives:

- first use of ReLU
- used Norm layers (not common anymore)
- heavy data augmentation
- dropout 0.5
- batch size 128
- SGD Momentum 0.9
- Learning rate 1e-2, reduced by 10 manually when val accuracy plateaus
- L2 weight decay 5e-4
- 7 CNN ensemble: 18.2% -> 15.4%

Figure copyright Alex Krizhevsky, Ilya Sutskever, and Geoffrey Hinton, 2012. Reproduced with permission.

Case Study: AlexNet

[Krizhevsky et al. 2012]

Full (simplified) AlexNet architecture:

[227x227x3] INPUT

[55x55x96] CONV1: 96 11x11 filters at stride 4, pad 0

[27x27x96] MAX POOL1: 3x3 filters at stride 2

[27x27x96] NORM1: Normalization layer

[27x27x256] CONV2: 256 5x5 filters at stride 1, pad 2

[13x13x256] MAX POOL2: 3x3 filters at stride 2

[13x13x256] NORM2: Normalization layer

[13x13x384] CONV3: 384 3x3 filters at stride 1, pad 1

[13x13x384] CONV4: 384 3x3 filters at stride 1, pad 1

[13x13x256] CONV5: 256 3x3 filters at stride 1, pad 1

[6x6x256] MAX POOL3: 3x3 filters at stride 2

[4096] FC6: 4096 neurons

[4096] FC7: 4096 neurons

[1000] FC8: 1000 neurons (class scores)

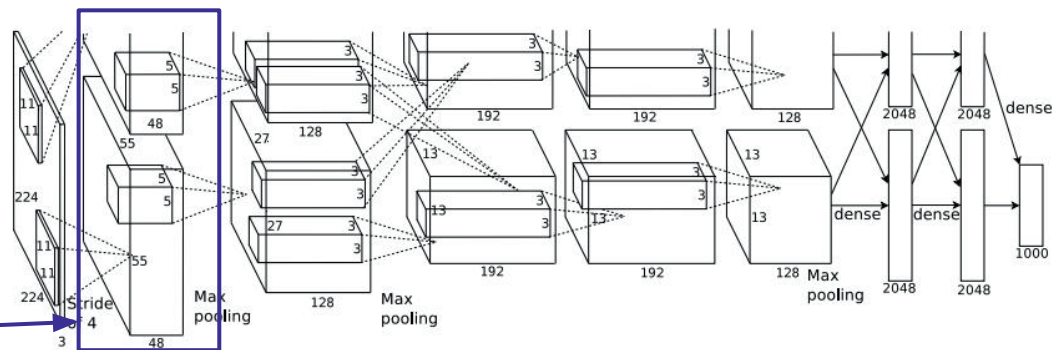

[55x55x48] x 2

Historical note: Trained on GTX 580 GPU with only 3 GB of memory. Network spread across 2 GPUs, half the neurons (feature maps) on each GPU.

Figure copyright Alex Krizhevsky, Ilya Sutskever, and Geoffrey Hinton, 2012. Reproduced with permission.

Case Study: AlexNet

[Krizhevsky et al. 2012]

Full (simplified) AlexNet architecture:

[227x227x3] INPUT

[55x55x96] **CONV1**: 96 11x11 filters at stride 4, pad 0

[27x27x96] **MAX POOL1**: 3x3 filters at stride 2

[27x27x96] **NORM1**: Normalization layer

[27x27x256] **CONV2**: 256 5x5 filters at stride 1, pad 2

[13x13x256] **MAX POOL2**: 3x3 filters at stride 2

[13x13x256] **NORM2**: Normalization layer

[13x13x384] **CONV3**: 384 3x3 filters at stride 1, pad 1

[13x13x384] **CONV4**: 384 3x3 filters at stride 1, pad 1

[13x13x256] **CONV5**: 256 3x3 filters at stride 1, pad 1

[6x6x256] **MAX POOL3**: 3x3 filters at stride 2

[4096] **FC6**: 4096 neurons

[4096] **FC7**: 4096 neurons

[1000] **FC8**: 1000 neurons (class scores)

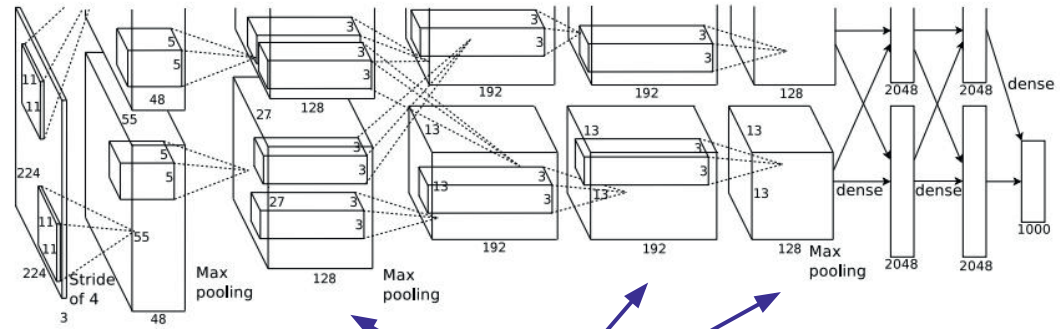

CONV1, CONV2, CONV4, CONV5:
Connections only with feature maps
on same GPU

Figure copyright Alex Krizhevsky, Ilya Sutskever, and Geoffrey Hinton, 2012. Reproduced with permission.

Case Study: AlexNet

[Krizhevsky et al. 2012]

Full (simplified) AlexNet architecture:

[227x227x3] INPUT

[55x55x96] **CONV1**: 96 11x11 filters at stride 4, pad 0

[27x27x96] **MAX POOL1**: 3x3 filters at stride 2

[27x27x96] **NORM1**: Normalization layer

[27x27x256] **CONV2**: 256 5x5 filters at stride 1, pad 2

[13x13x256] **MAX POOL2**: 3x3 filters at stride 2

[13x13x256] **NORM2**: Normalization layer

[13x13x384] **CONV3**: 384 3x3 filters at stride 1, pad 1

[13x13x384] **CONV4**: 384 3x3 filters at stride 1, pad 1

[13x13x256] **CONV5**: 256 3x3 filters at stride 1, pad 1

[6x6x256] **MAX POOL3**: 3x3 filters at stride 2

[4096] **FC6**: 4096 neurons

[4096] **FC7**: 4096 neurons

[1000] **FC8**: 1000 neurons (class scores)

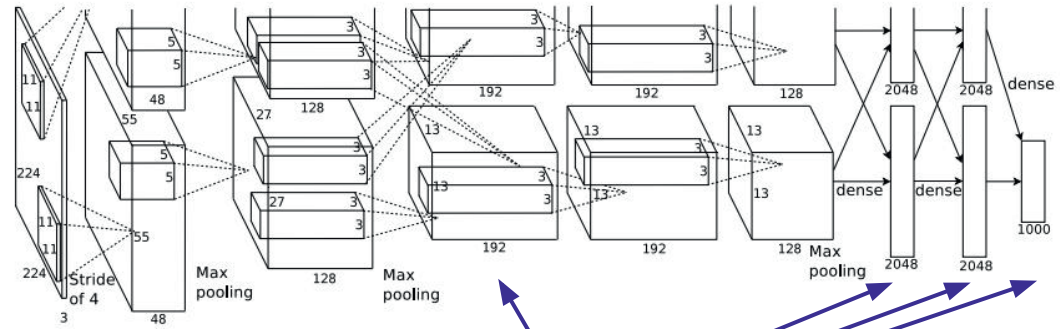

CONV3, FC6, FC7, FC8:

Connections with all feature maps in preceding layer, communication across GPUs

Figure copyright Alex Krizhevsky, Ilya Sutskever, and Geoffrey Hinton, 2012. Reproduced with permission.

ImageNet Large Scale Visual Recognition Challenge (ILSVRC) winners

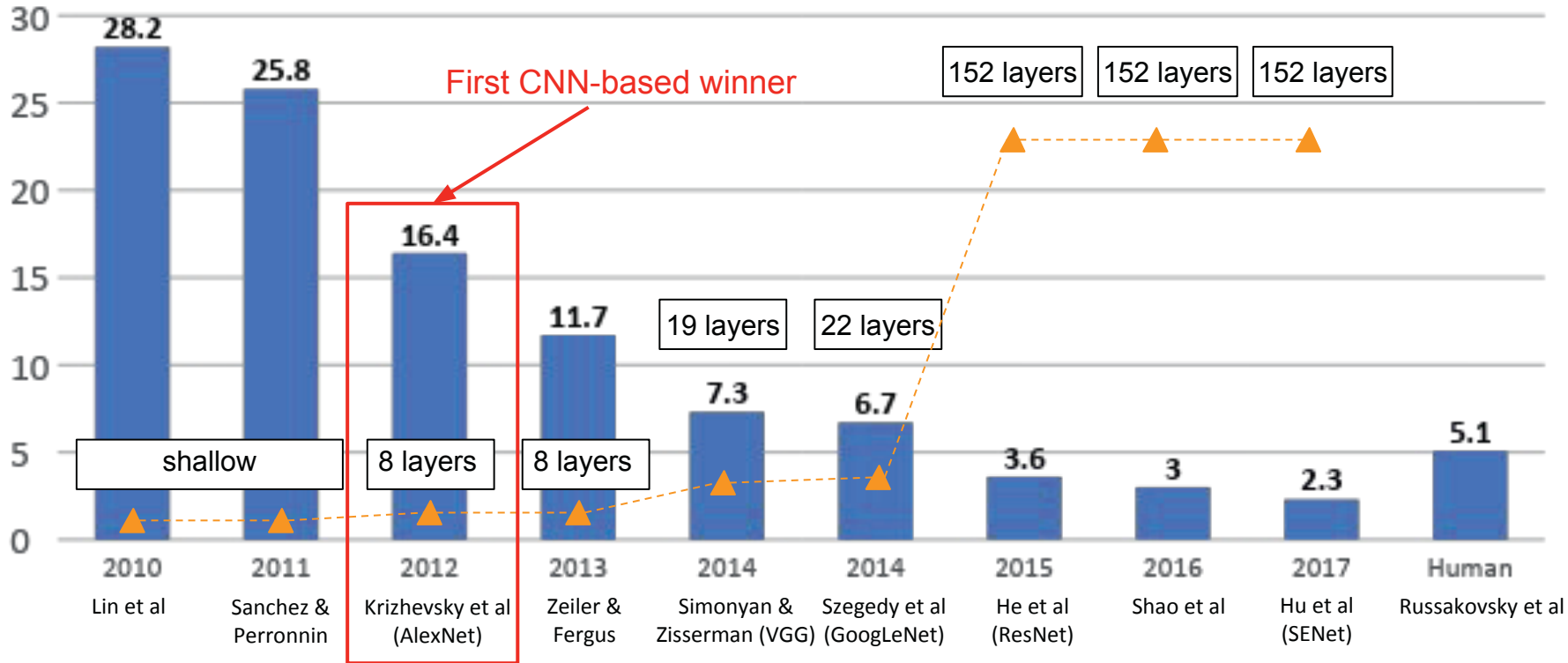

ImageNet Large Scale Visual Recognition Challenge (ILSVRC) winners

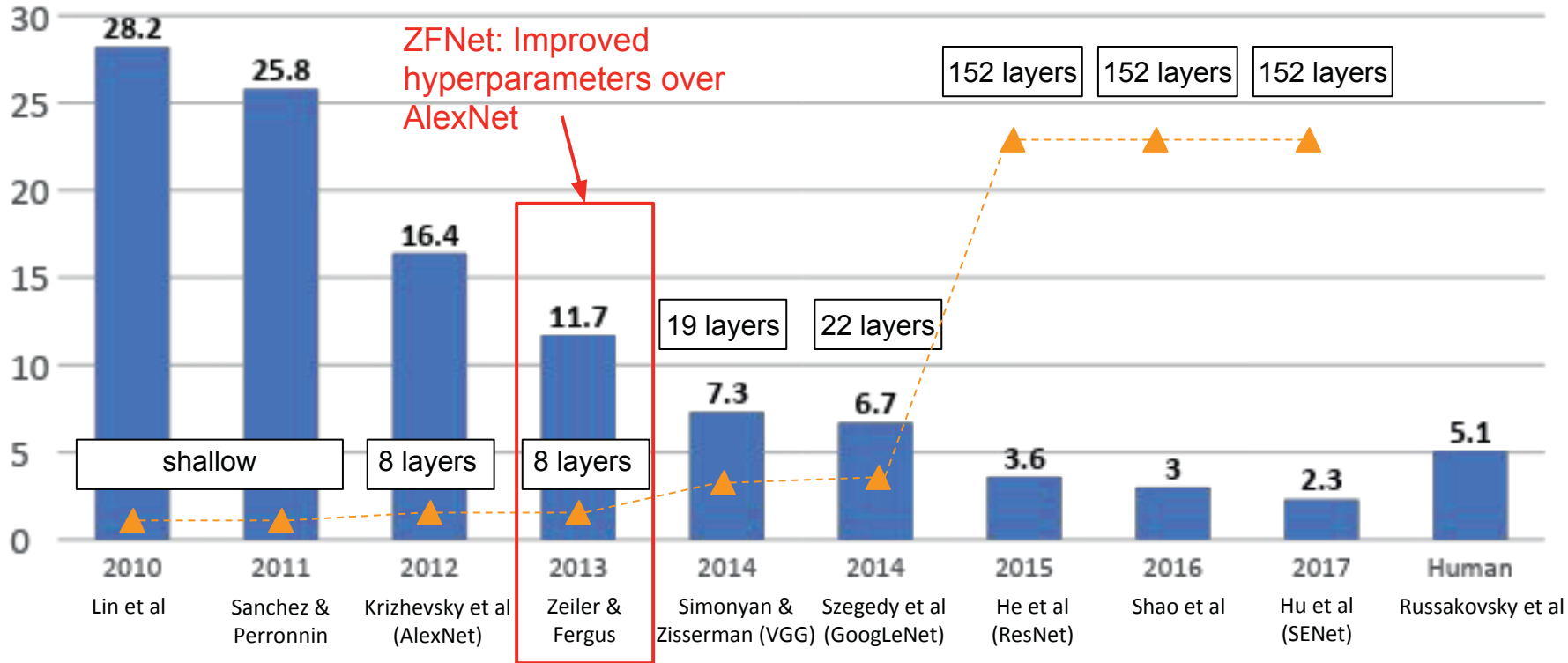

ImageNet Large Scale Visual Recognition Challenge (ILSVRC) winners

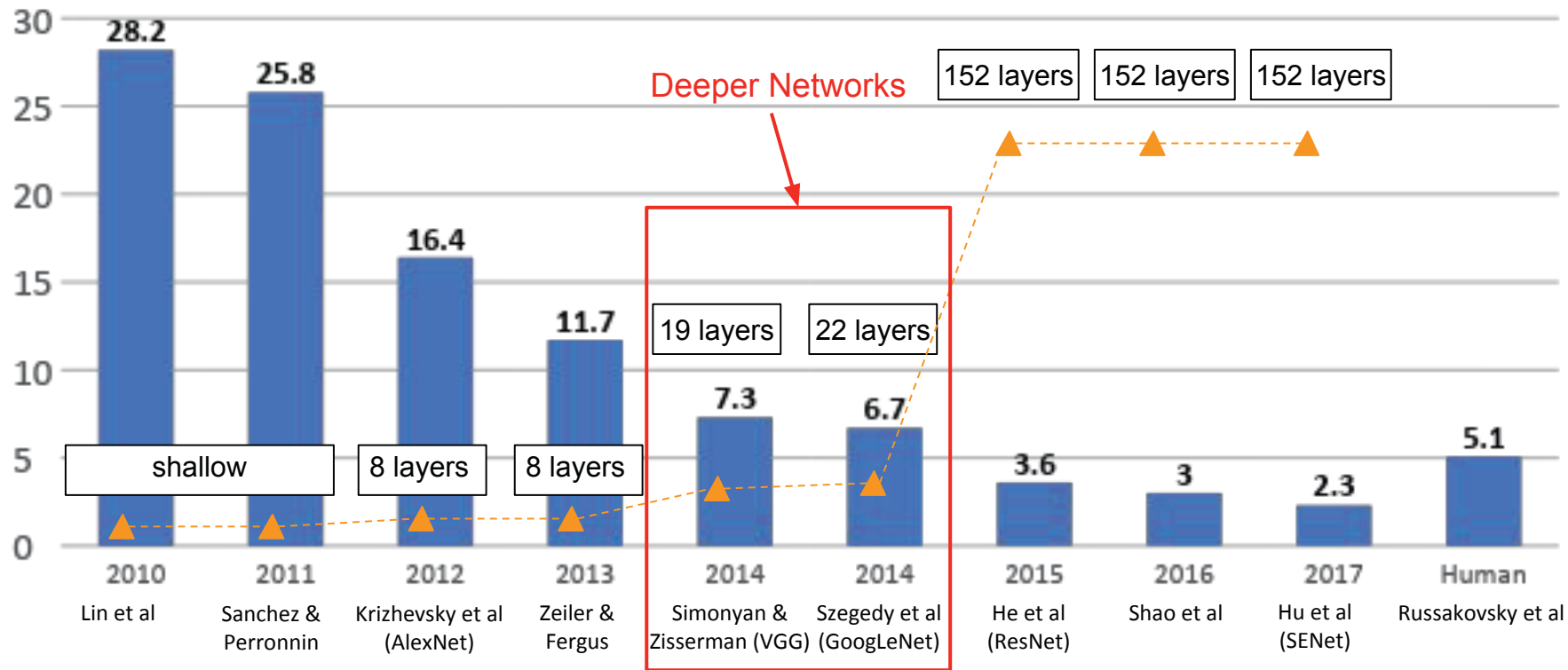

Case Study: VGGNet

[Simonyan and Zisserman, 2014]

Small filters, Deeper networks

8 layers (AlexNet)

-> 16 - 19 layers (VGG16Net)

Only 3x3 CONV stride 1, pad 1
and 2x2 MAX POOL stride 2

11.7% top 5 error in ILSVRC'13 (ZFNet)

-> 7.3% top 5 error in ILSVRC'14

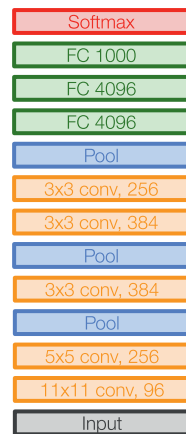

AlexNet

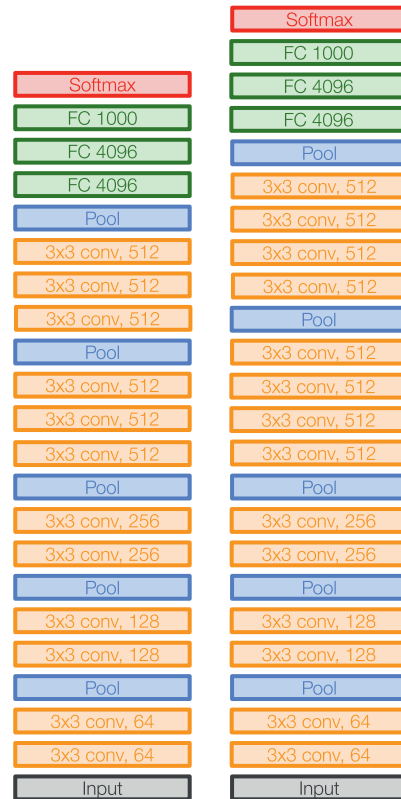

VGG16

VGG19

Case Study: VGGNet

[Simonyan and Zisserman, 2014]

Q: Why use smaller filters? (3x3 conv)

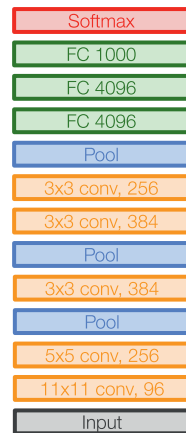

AlexNet

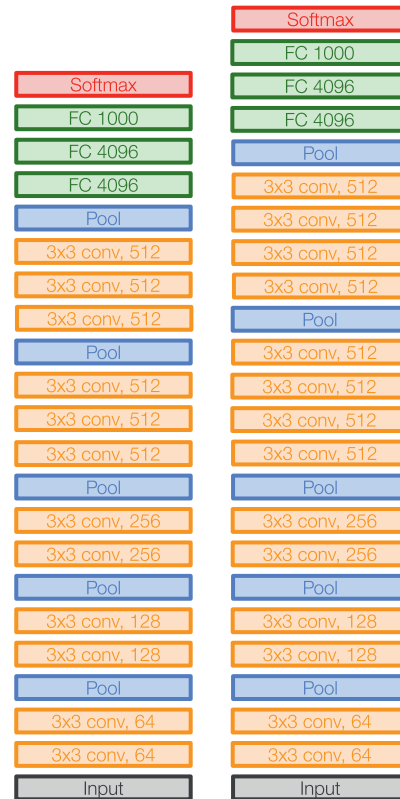

VGG16

VGG19

Case Study: VGGNet

[Simonyan and Zisserman, 2014]

Q: Why use smaller filters? (3x3 conv)

Stack of three 3x3 conv (stride 1) layers has same **effective receptive field** as one 7x7 conv layer

Q: What is the effective receptive field of three 3x3 conv (stride 1) layers?

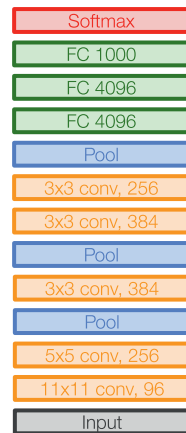

AlexNet

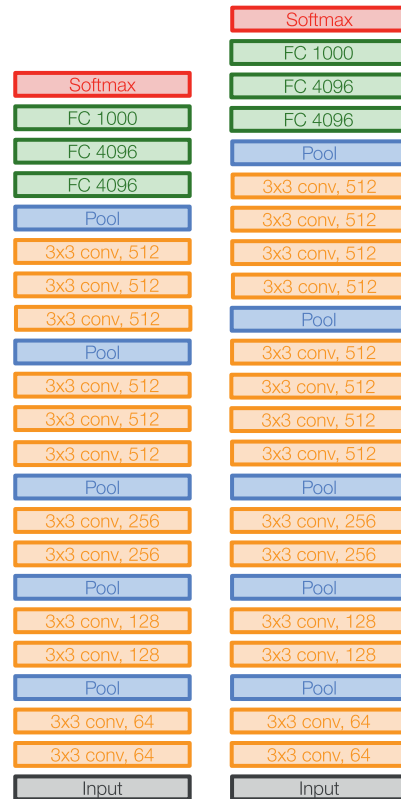

VGG16

VGG19

Case Study: VGGNet

[Simonyan and Zisserman, 2014]

Q: What is the effective receptive field of three 3x3 conv (stride 1) layers?

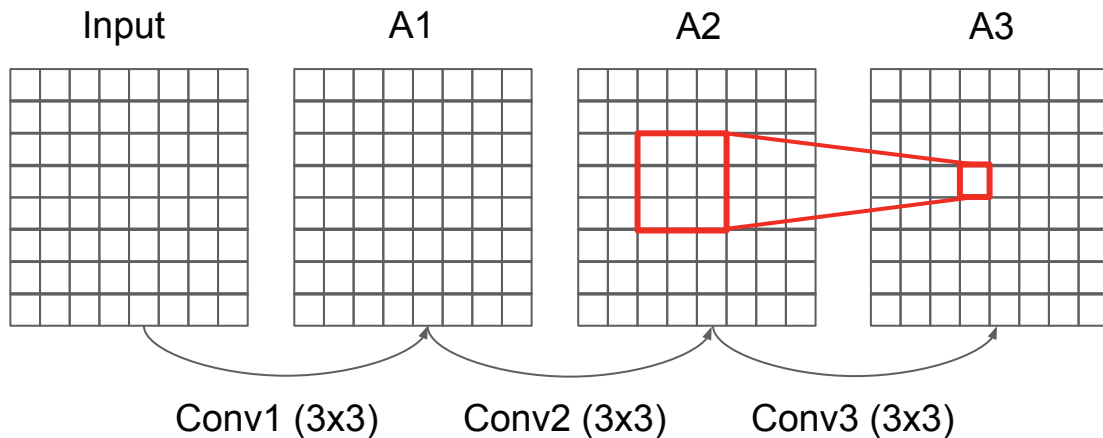

Case Study: VGGNet

[Simonyan and Zisserman, 2014]

Q: What is the effective receptive field of three 3x3 conv (stride 1) layers?

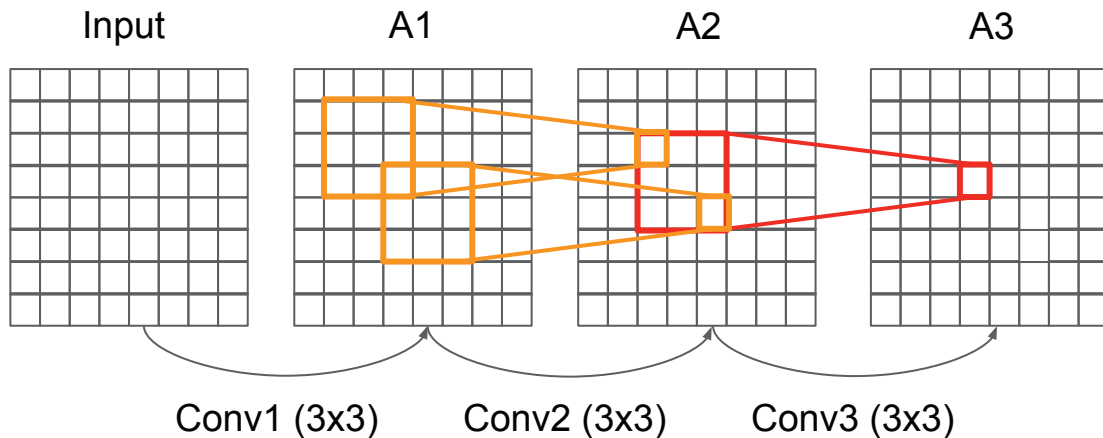

VGG16

VGG19

Case Study: VGGNet

[Simonyan and Zisserman, 2014]

Q: What is the effective receptive field of three 3x3 conv (stride 1) layers?

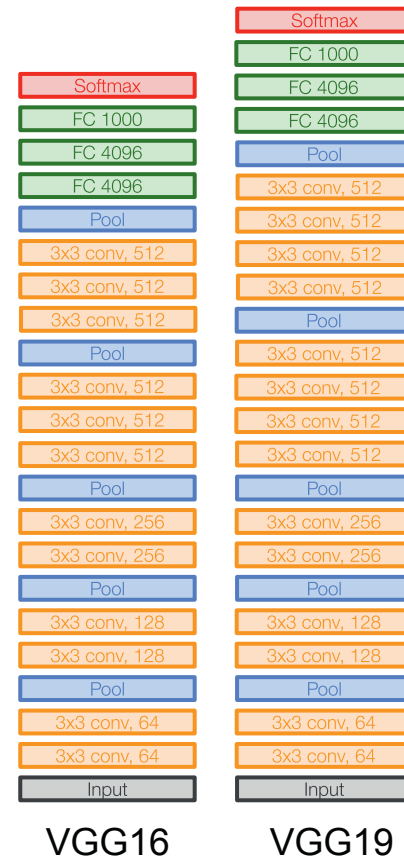
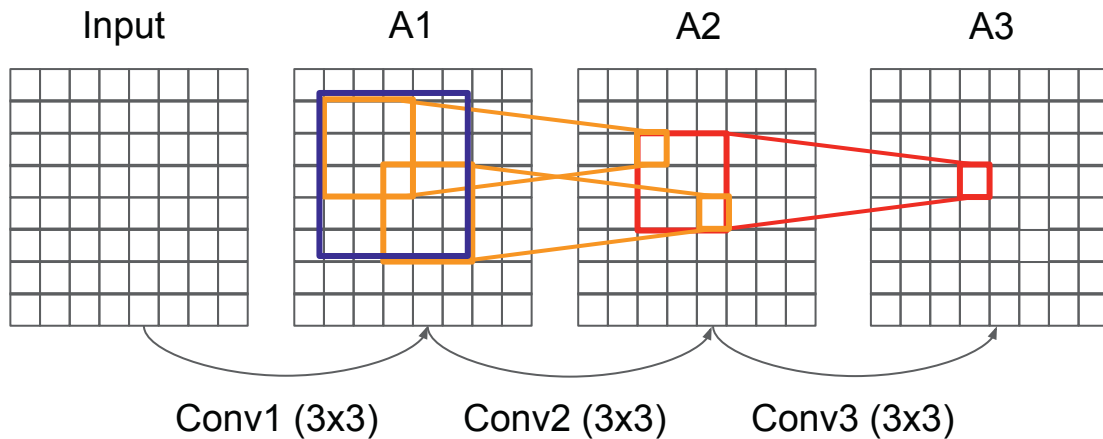

Case Study: VGGNet

[Simonyan and Zisserman, 2014]

Q: What is the effective receptive field of three 3x3 conv (stride 1) layers?

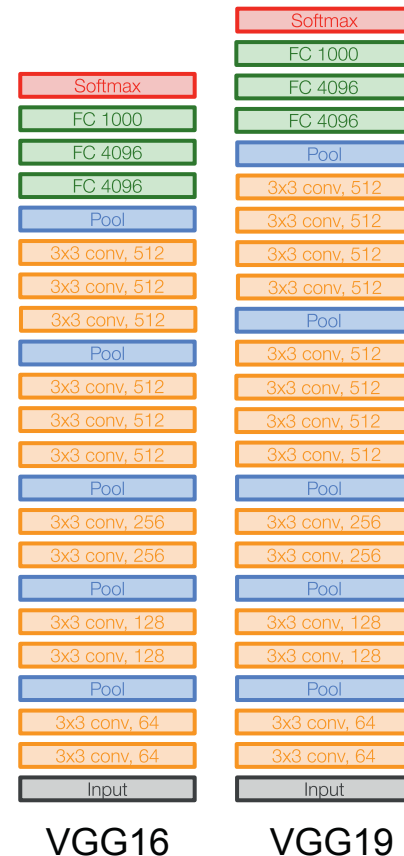
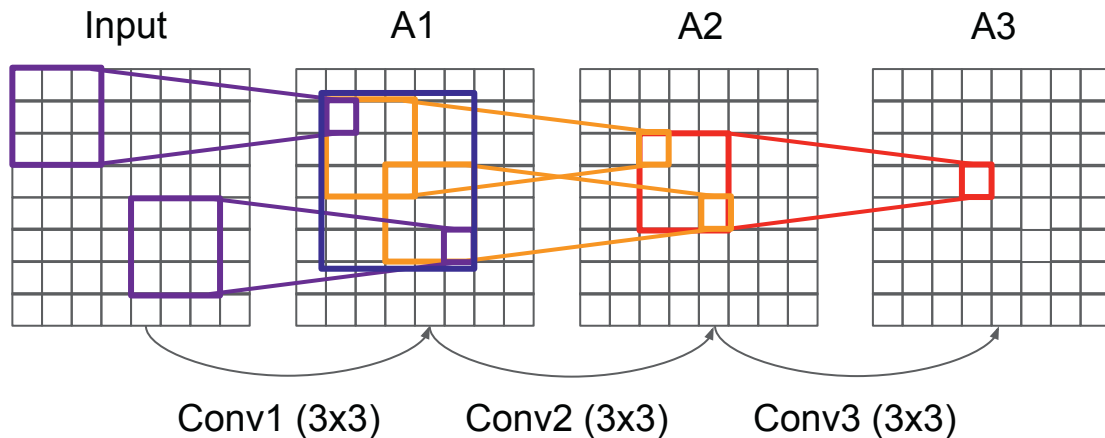

Case Study: VGGNet

[Simonyan and Zisserman, 2014]

Q: Why use smaller filters? (3x3 conv)

Stack of three 3x3 conv (stride 1) layers has same **effective receptive field** as one 7x7 conv layer

[7x7]

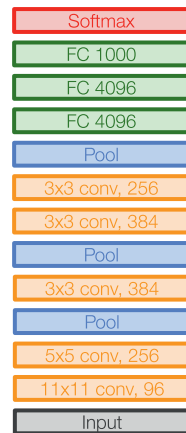

AlexNet

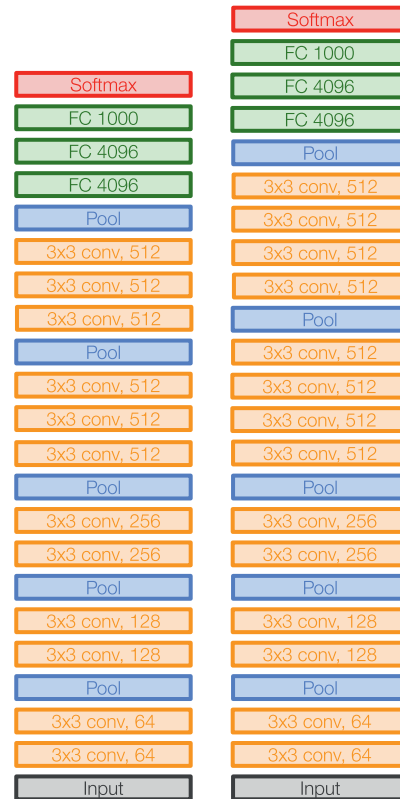

VGG16

VGG19

Case Study: VGGNet

[Simonyan and Zisserman, 2014]

Q: Why use smaller filters? (3x3 conv)

Stack of three 3x3 conv (stride 1) layers has same **effective receptive field** as one 7x7 conv layer

But deeper, more non-linearities

And fewer parameters: $3 * (3^2C^2)$ vs. 7^2C^2 for C channels per layer

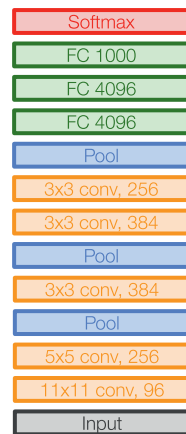

AlexNet

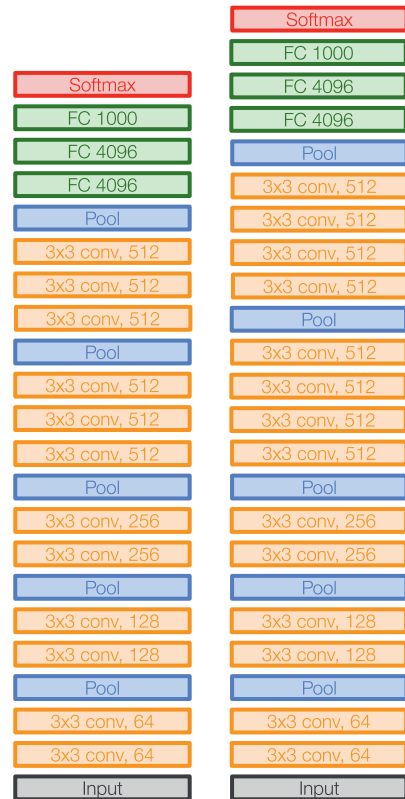

VGG16

VGG19

INPUT: [224x224x3] memory: 224*224*3=150K params: 0 (not counting biases)

CONV3-64: [224x224x64] memory: 224*224*64=3.2M params: $(3*3*3)*64 = 1,728$

CONV3-64: [224x224x64] memory: 224*224*64=3.2M params: $(3*3*64)*64 = 36,864$

POOL2: [112x112x64] memory: 112*112*64=800K params: 0

CONV3-128: [112x112x128] memory: 112*112*128=1.6M params: $(3*3*64)*128 = 73,728$

CONV3-128: [112x112x128] memory: 112*112*128=1.6M params: $(3*3*128)*128 = 147,456$

POOL2: [56x56x128] memory: 56*56*128=400K params: 0

CONV3-256: [56x56x256] memory: 56*56*256=800K params: $(3*3*128)*256 = 294,912$

CONV3-256: [56x56x256] memory: 56*56*256=800K params: $(3*3*256)*256 = 589,824$

CONV3-256: [56x56x256] memory: 56*56*256=800K params: $(3*3*256)*256 = 589,824$

POOL2: [28x28x256] memory: 28*28*256=200K params: 0

CONV3-512: [28x28x512] memory: 28*28*512=400K params: $(3*3*256)*512 = 1,179,648$

CONV3-512: [28x28x512] memory: 28*28*512=400K params: $(3*3*512)*512 = 2,359,296$

CONV3-512: [28x28x512] memory: 28*28*512=400K params: $(3*3*512)*512 = 2,359,296$

POOL2: [14x14x512] memory: 14*14*512=100K params: 0

CONV3-512: [14x14x512] memory: 14*14*512=100K params: $(3*3*512)*512 = 2,359,296$

CONV3-512: [14x14x512] memory: 14*14*512=100K params: $(3*3*512)*512 = 2,359,296$

CONV3-512: [14x14x512] memory: 14*14*512=100K params: $(3*3*512)*512 = 2,359,296$

POOL2: [7x7x512] memory: 7*7*512=25K params: 0

FC: [1x1x4096] memory: 4096 params: $7*7*512*4096 = 102,760,448$

FC: [1x1x4096] memory: 4096 params: $4096*4096 = 16,777,216$

FC: [1x1x1000] memory: 1000 params: $4096*1000 = 4,096,000$

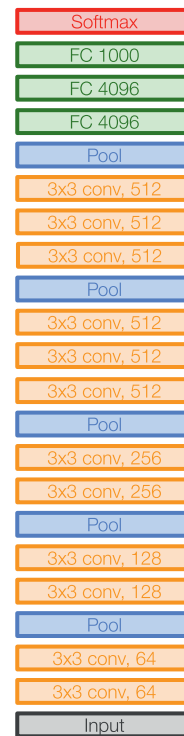

VGG16

INPUT: [224x224x3] memory: 224*224*3=150K params: 0 (not counting biases)

CONV3-64: [224x224x64] memory: 224*224*64=3.2M params: (3*3*3)*64 = 1,728

CONV3-64: [224x224x64] memory: 224*224*64=3.2M params: (3*3*64)*64 = 36,864

POOL2: [112x112x64] memory: 112*112*64=800K params: 0

CONV3-128: [112x112x128] memory: 112*112*128=1.6M params: (3*3*64)*128 = 73,728

CONV3-128: [112x112x128] memory: 112*112*128=1.6M params: (3*3*128)*128 = 147,456

POOL2: [56x56x128] memory: 56*56*128=400K params: 0

CONV3-256: [56x56x256] memory: 56*56*256=800K params: (3*3*128)*256 = 294,912

CONV3-256: [56x56x256] memory: 56*56*256=800K params: (3*3*256)*256 = 589,824

CONV3-256: [56x56x256] memory: 56*56*256=800K params: (3*3*256)*256 = 589,824

POOL2: [28x28x256] memory: 28*28*256=200K params: 0

CONV3-512: [28x28x512] memory: 28*28*512=400K params: (3*3*256)*512 = 1,179,648

CONV3-512: [28x28x512] memory: 28*28*512=400K params: (3*3*512)*512 = 2,359,296

CONV3-512: [28x28x512] memory: 28*28*512=400K params: (3*3*512)*512 = 2,359,296

POOL2: [14x14x512] memory: 14*14*512=100K params: 0

CONV3-512: [14x14x512] memory: 14*14*512=100K params: (3*3*512)*512 = 2,359,296

CONV3-512: [14x14x512] memory: 14*14*512=100K params: (3*3*512)*512 = 2,359,296

CONV3-512: [14x14x512] memory: 14*14*512=100K params: (3*3*512)*512 = 2,359,296

POOL2: [7x7x512] memory: 7*7*512=25K params: 0

FC: [1x1x4096] memory: 4096 params: 7*7*512*4096 = 102,760,448

FC: [1x1x4096] memory: 4096 params: 4096*4096 = 16,777,216

FC: [1x1x1000] memory: 1000 params: 4096*1000 = 4,096,000

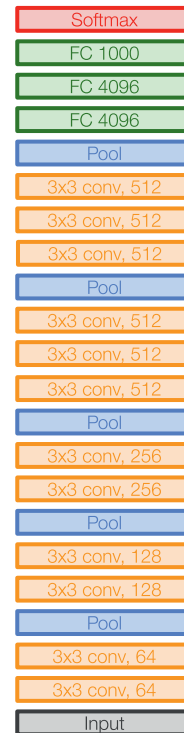

VGG16

TOTAL memory: 24M * 4 bytes \approx 96MB / image (for a forward pass)

TOTAL params: 138M parameters

INPUT: [224x224x3] memory: $224*224*3=150\text{K}$ params: 0 (not counting biases)

CONV3-64: [224x224x64] memory: $224*224*64=3.2\text{M}$ params: $(3*3*3)*64 = 1,728$

CONV3-64: [224x224x64] memory: $224*224*64=3.2\text{M}$ params: $(3*3*64)*64 = 36,864$

POOL2: [112x112x64] memory: $112*112*64=800\text{K}$ params: 0

CONV3-128: [112x112x128] memory: $112*112*128=1.6\text{M}$ params: $(3*3*64)*128 = 73,728$

CONV3-128: [112x112x128] memory: $112*112*128=1.6\text{M}$ params: $(3*3*128)*128 = 147,456$

POOL2: [56x56x128] memory: $56*56*128=400\text{K}$ params: 0

CONV3-256: [56x56x256] memory: $56*56*256=800\text{K}$ params: $(3*3*128)*256 = 294,912$

CONV3-256: [56x56x256] memory: $56*56*256=800\text{K}$ params: $(3*3*256)*256 = 589,824$

CONV3-256: [56x56x256] memory: $56*56*256=800\text{K}$ params: $(3*3*256)*256 = 589,824$

POOL2: [28x28x256] memory: $28*28*256=200\text{K}$ params: 0

CONV3-512: [28x28x512] memory: $28*28*512=400\text{K}$ params: $(3*3*256)*512 = 1,179,648$

CONV3-512: [28x28x512] memory: $28*28*512=400\text{K}$ params: $(3*3*512)*512 = 2,359,296$

CONV3-512: [28x28x512] memory: $28*28*512=400\text{K}$ params: $(3*3*512)*512 = 2,359,296$

POOL2: [14x14x512] memory: $14*14*512=100\text{K}$ params: 0

CONV3-512: [14x14x512] memory: $14*14*512=100\text{K}$ params: $(3*3*512)*512 = 2,359,296$

CONV3-512: [14x14x512] memory: $14*14*512=100\text{K}$ params: $(3*3*512)*512 = 2,359,296$

CONV3-512: [14x14x512] memory: $14*14*512=100\text{K}$ params: $(3*3*512)*512 = 2,359,296$

POOL2: [7x7x512] memory: $7*7*512=25\text{K}$ params: 0

FC: [1x1x4096] memory: 4096 params: $7*7*512*4096 = 102,760,448$

FC: [1x1x4096] memory: 4096 params: $4096*4096 = 16,777,216$

FC: [1x1x1000] memory: 1000 params: $4096*1000 = 4,096,000$

TOTAL memory: $24\text{M} * 4 \text{ bytes} \approx 96\text{MB} / \text{image}$ (only forward! ~ 2 for bwd)

TOTAL params: 138M parameters

Note:

Most memory is in early CONV

Most params are in late FC

INPUT: [224x224x3] memory: 224*224*3=150K params: 0 (not counting biases)

CONV3-64: [224x224x64] memory: 224*224*64=3.2M params: (3*3*3)*64 = 1,728

CONV3-64: [224x224x64] memory: 224*224*64=3.2M params: (3*3*64)*64 = 36,864

POOL2: [112x112x64] memory: 112*112*64=800K params: 0

CONV3-128: [112x112x128] memory: 112*112*128=1.6M params: (3*3*64)*128 = 73,728

CONV3-128: [112x112x128] memory: 112*112*128=1.6M params: (3*3*128)*128 = 147,456

POOL2: [56x56x128] memory: 56*56*128=400K params: 0

CONV3-256: [56x56x256] memory: 56*56*256=800K params: (3*3*128)*256 = 294,912

CONV3-256: [56x56x256] memory: 56*56*256=800K params: (3*3*256)*256 = 589,824

CONV3-256: [56x56x256] memory: 56*56*256=800K params: (3*3*256)*256 = 589,824

POOL2: [28x28x256] memory: 28*28*256=200K params: 0

CONV3-512: [28x28x512] memory: 28*28*512=400K params: (3*3*256)*512 = 1,179,648

CONV3-512: [28x28x512] memory: 28*28*512=400K params: (3*3*512)*512 = 2,359,296

CONV3-512: [28x28x512] memory: 28*28*512=400K params: (3*3*512)*512 = 2,359,296

POOL2: [14x14x512] memory: 14*14*512=100K params: 0

CONV3-512: [14x14x512] memory: 14*14*512=100K params: (3*3*512)*512 = 2,359,296

CONV3-512: [14x14x512] memory: 14*14*512=100K params: (3*3*512)*512 = 2,359,296

CONV3-512: [14x14x512] memory: 14*14*512=100K params: (3*3*512)*512 = 2,359,296

POOL2: [7x7x512] memory: 7*7*512=25K params: 0

FC: [1x1x4096] memory: 4096 params: 7*7*512*4096 = 102,760,448

FC: [1x1x4096] memory: 4096 params: 4096*4096 = 16,777,216

FC: [1x1x1000] memory: 1000 params: 4096*1000 = 4,096,000

TOTAL memory: 24M * 4 bytes \approx 96MB / image (only forward! \sim *2 for bwd)

TOTAL params: 138M parameters



VGG16

Common names

Case Study: VGGNet

[Simonyan and Zisserman, 2014]

Details:

- ILSVRC'14 2nd in classification, 1st in localization
- Similar training procedure as Krizhevsky 2012
- No Local Response Normalisation (LRN)
- Use VGG16 or VGG19 (VGG19 only slightly better, more memory)
- Use ensembles for best results
- FC7 features generalize well to other tasks

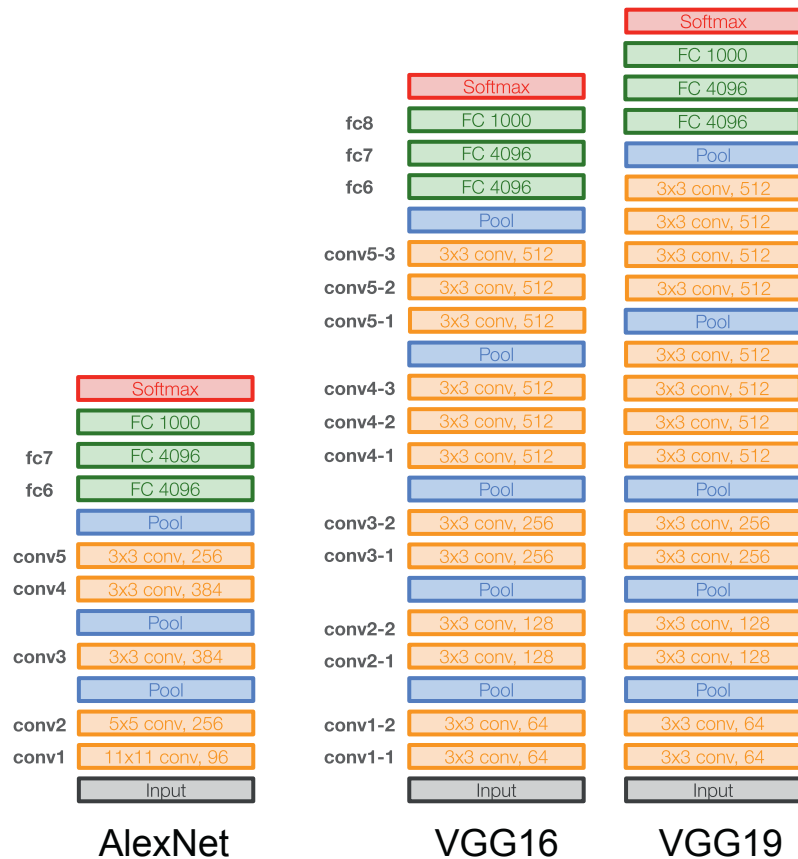

ImageNet Large Scale Visual Recognition Challenge (ILSVRC) winners

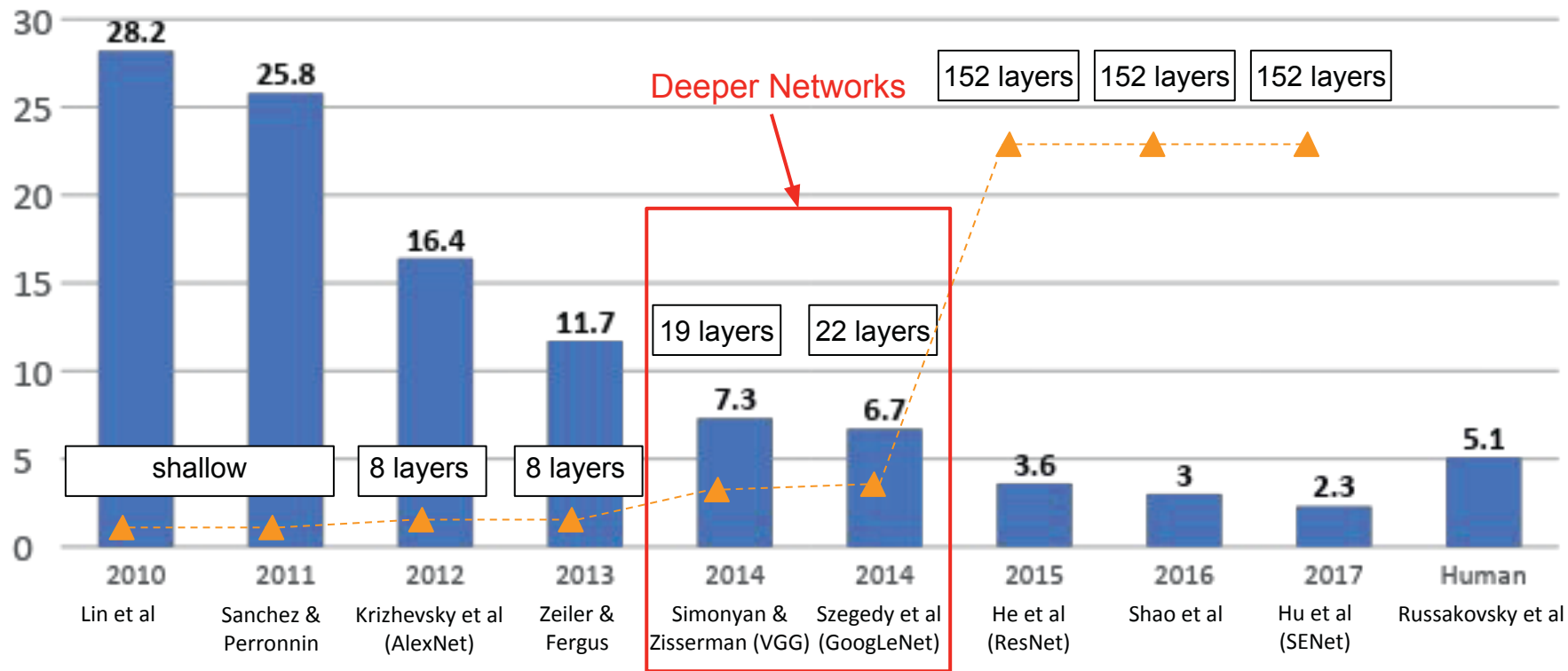

Case Study: GoogLeNet

[Szegedy et al., 2014]

Deeper networks, with computational efficiency

- ILSVRC'14 classification winner (6.7% top 5 error)
- 22 layers
- Only 5 million parameters!
12x less than AlexNet
27x less than VGG-16
- Efficient “Inception” module
- No FC layers

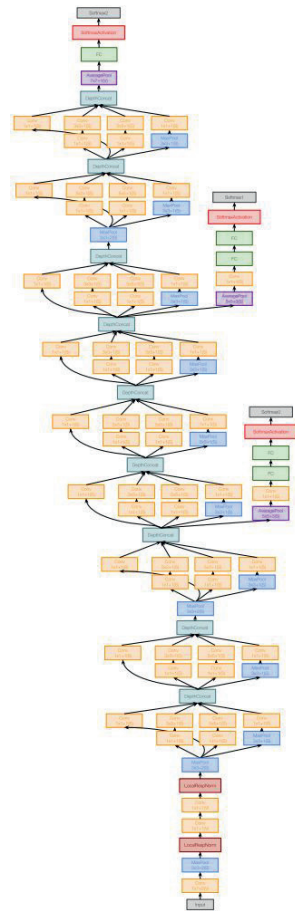
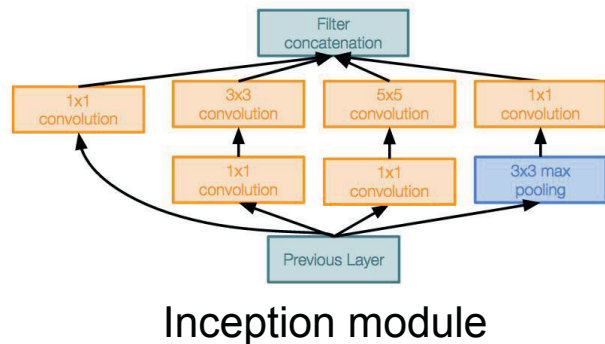

Case Study: GoogLeNet

[Szegedy et al., 2014]

“Inception module”: design a good local network topology (network within a network) and then stack these modules on top of each other

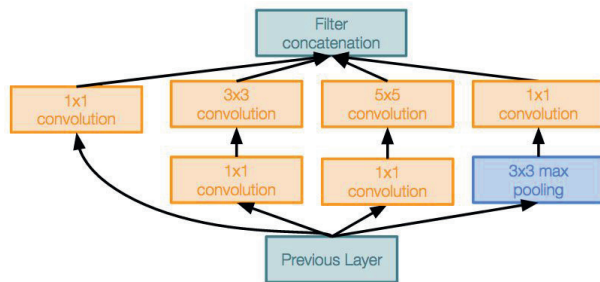

Inception module

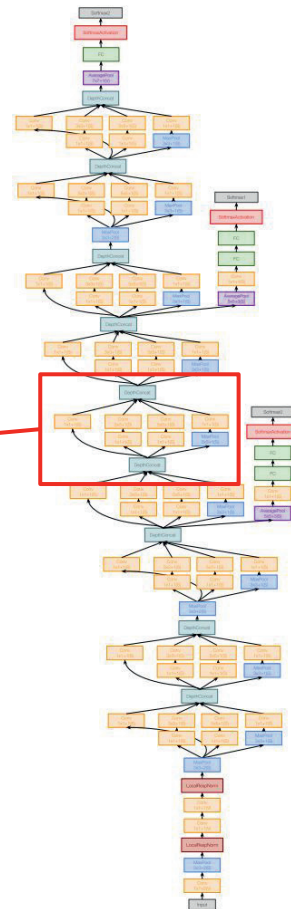

Case Study: GoogLeNet

[Szegedy et al., 2014]

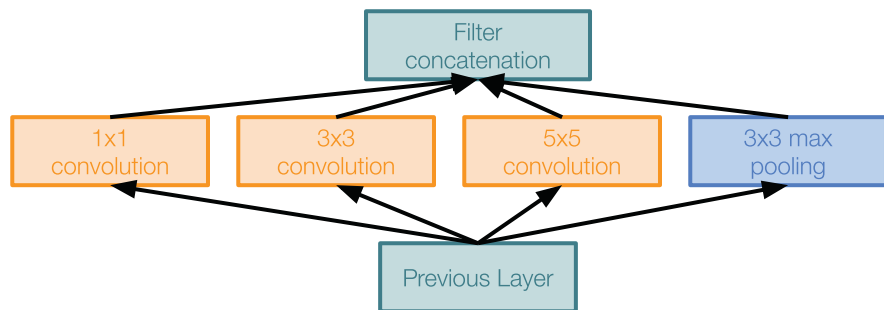

Naive Inception module

Apply parallel filter operations on the input from previous layer:

- Multiple receptive field sizes for convolution (1x1, 3x3, 5x5)
- Pooling operation (3x3)

Concatenate all filter outputs together channel-wise

Case Study: GoogLeNet

[Szegedy et al., 2014]

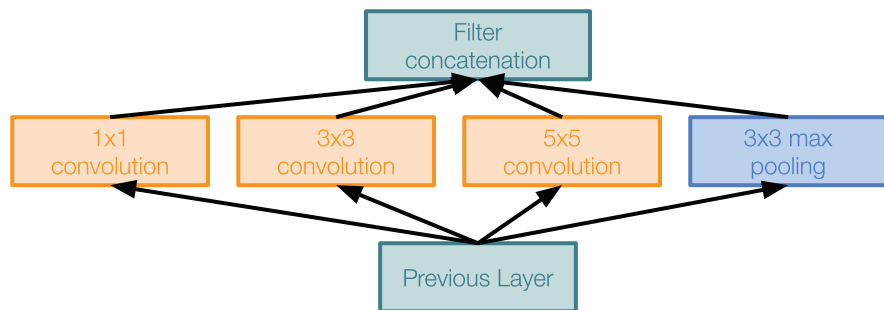

Naive Inception module

Apply parallel filter operations on the input from previous layer:

- Multiple receptive field sizes for convolution (1x1, 3x3, 5x5)
- Pooling operation (3x3)

Concatenate all filter outputs together channel-wise

Q: What is the problem with this?
[Hint: Computational complexity]

Case Study: GoogLeNet

[Szegedy et al., 2014]

Q: What is the problem with this?
[Hint: Computational complexity]

Example:

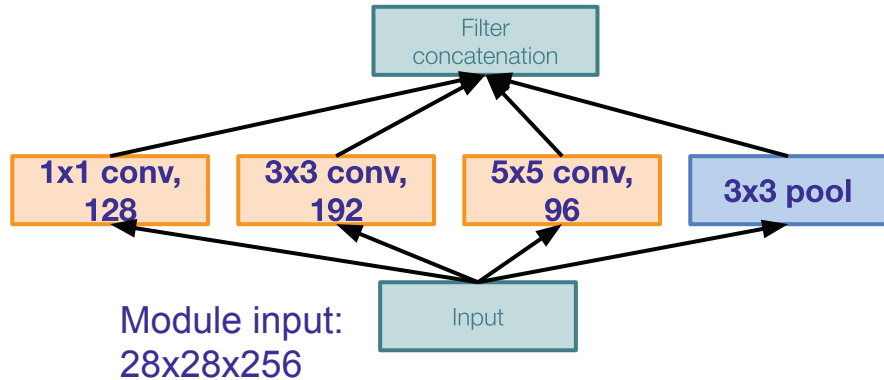

Naive Inception module

Case Study: GoogLeNet

[Szegedy et al., 2014]

Q: What is the problem with this?
[Hint: Computational complexity]

Example:

Q1: What are the output sizes of all different filter operations?

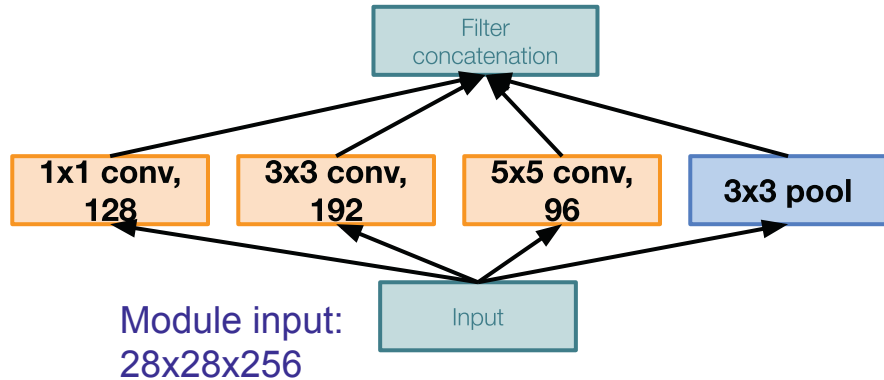

Naive Inception module

Case Study: GoogLeNet

[Szegedy et al., 2014]

Q: What is the problem with this?
[Hint: Computational complexity]

Example:

Q1: What are the output sizes of all different filter operations?

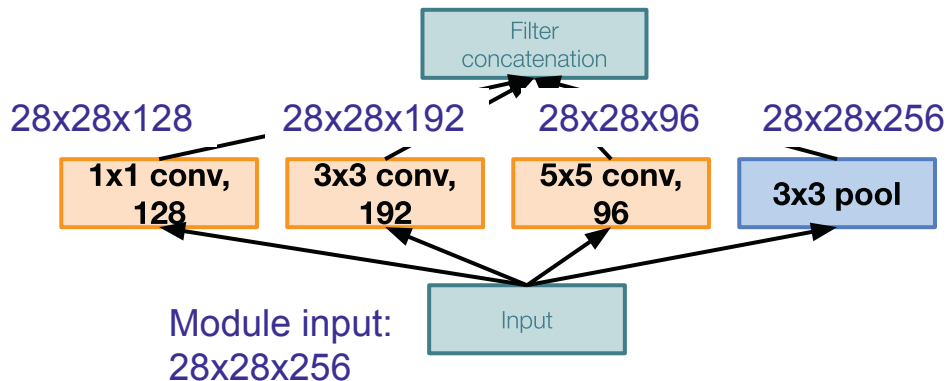

Naive Inception module

Case Study: GoogLeNet

[Szegedy et al., 2014]

Q: What is the problem with this?
[Hint: Computational complexity]

Example:

Q2: What is output size after filter concatenation?

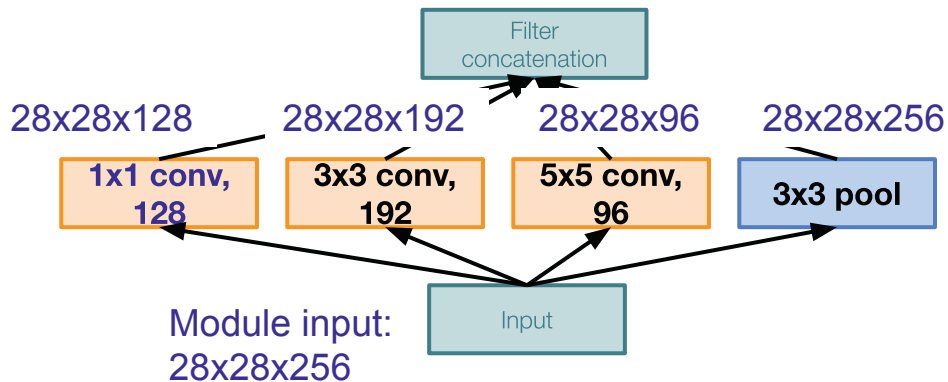

Naive Inception module

Case Study: GoogLeNet

[Szegedy et al., 2014]

Q: What is the problem with this?
[Hint: Computational complexity]

Example:

Q2: What is output size after filter concatenation?

$$28 \times 28 \times (128 + 192 + 96 + 256) = 28 \times 28 \times 672$$

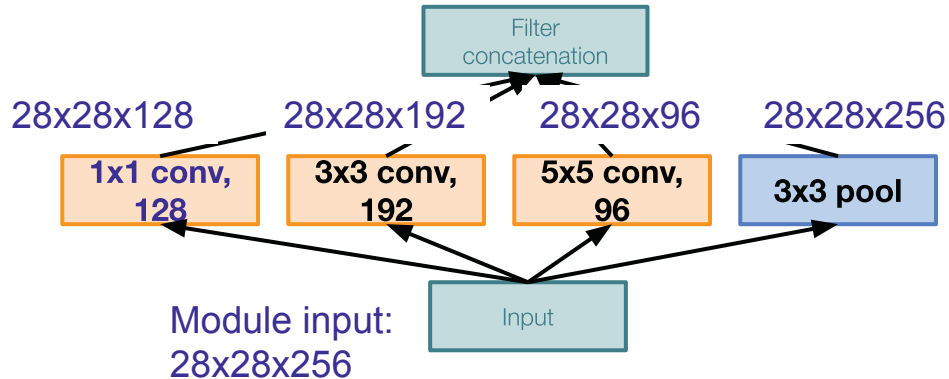

Naive Inception module

Case Study: GoogLeNet

[Szegedy et al., 2014]

Example:

Q2: What is output size after filter concatenation?

$$28 \times 28 \times (128 + 192 + 96 + 256) = 28 \times 28 \times 672$$

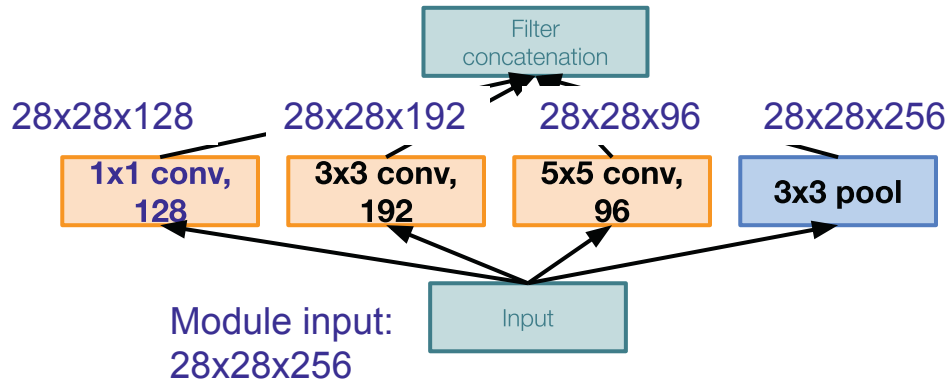

Naive Inception module

Q: What is the problem with this?
[Hint: Computational complexity]

Conv Ops:

[1×1 conv, 128] $28 \times 28 \times 128 \times 1 \times 1 \times 256$

[3×3 conv, 192] $28 \times 28 \times 192 \times 3 \times 3 \times 256$

[5×5 conv, 96] $28 \times 28 \times 96 \times 5 \times 5 \times 256$

Total: 854M ops

Case Study: GoogLeNet

[Szegedy et al., 2014]

Example:

Q2: What is output size after filter concatenation?

$$28 \times 28 \times (128 + 192 + 96 + 256) = 28 \times 28 \times 672$$

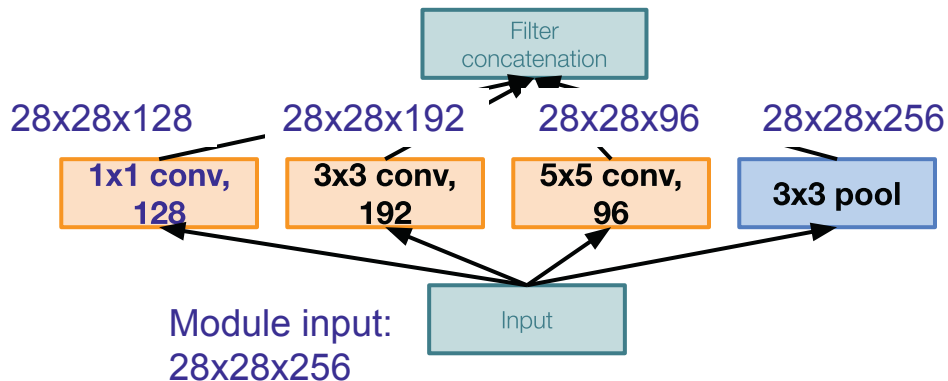

Naive Inception module

Q: What is the problem with this?
[Hint: Computational complexity]

Conv Ops:

[1×1 conv, 128] $28 \times 28 \times 128 \times 1 \times 1 \times 256$
[3×3 conv, 192] $28 \times 28 \times 192 \times 3 \times 3 \times 256$
[5×5 conv, 96] $28 \times 28 \times 96 \times 5 \times 5 \times 256$

Total: 854M ops

Very expensive compute

Pooling layer also preserves feature depth, which means total depth after concatenation can only grow at every layer!

Case Study: GoogLeNet

[Szegedy et al., 2014]

Example:

Q2: What is output size after filter concatenation?

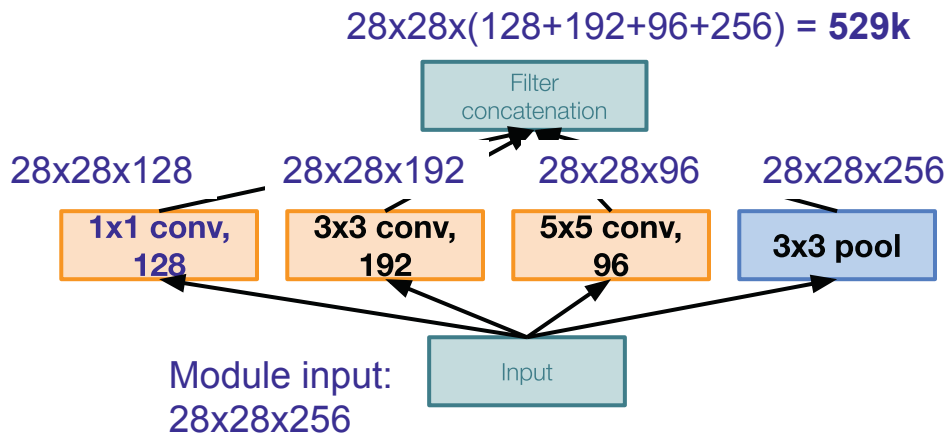

Naive Inception module

Q: What is the problem with this?
[Hint: Computational complexity]

Solution: “bottleneck” layers that use 1x1 convolutions to reduce feature channel size

Review: 1x1 convolutions

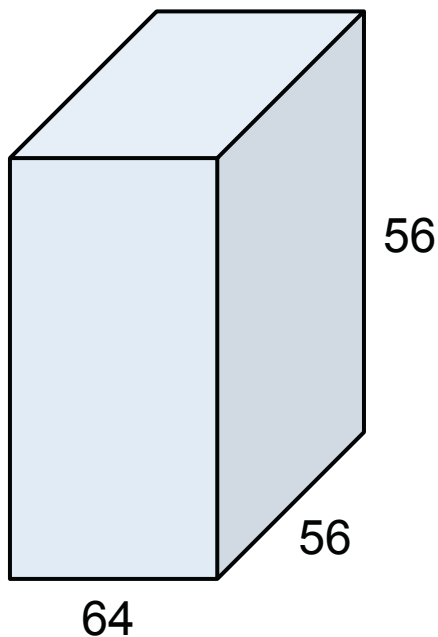

1x1 CONV
with 32 filters

→

(each filter has size
1x1x64, and performs a
64-dimensional dot
product)

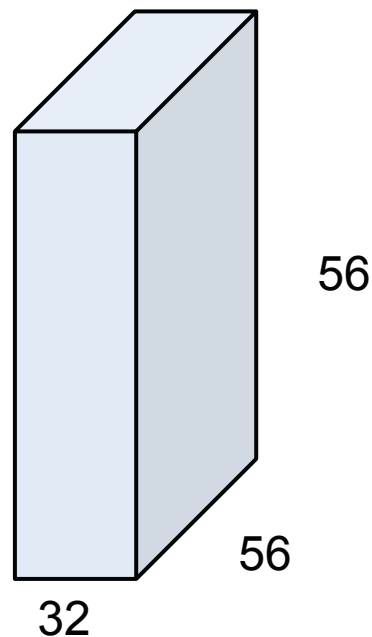

Review: 1x1 convolutions

Alternatively, interpret it as applying the same FC layer on each input pixel

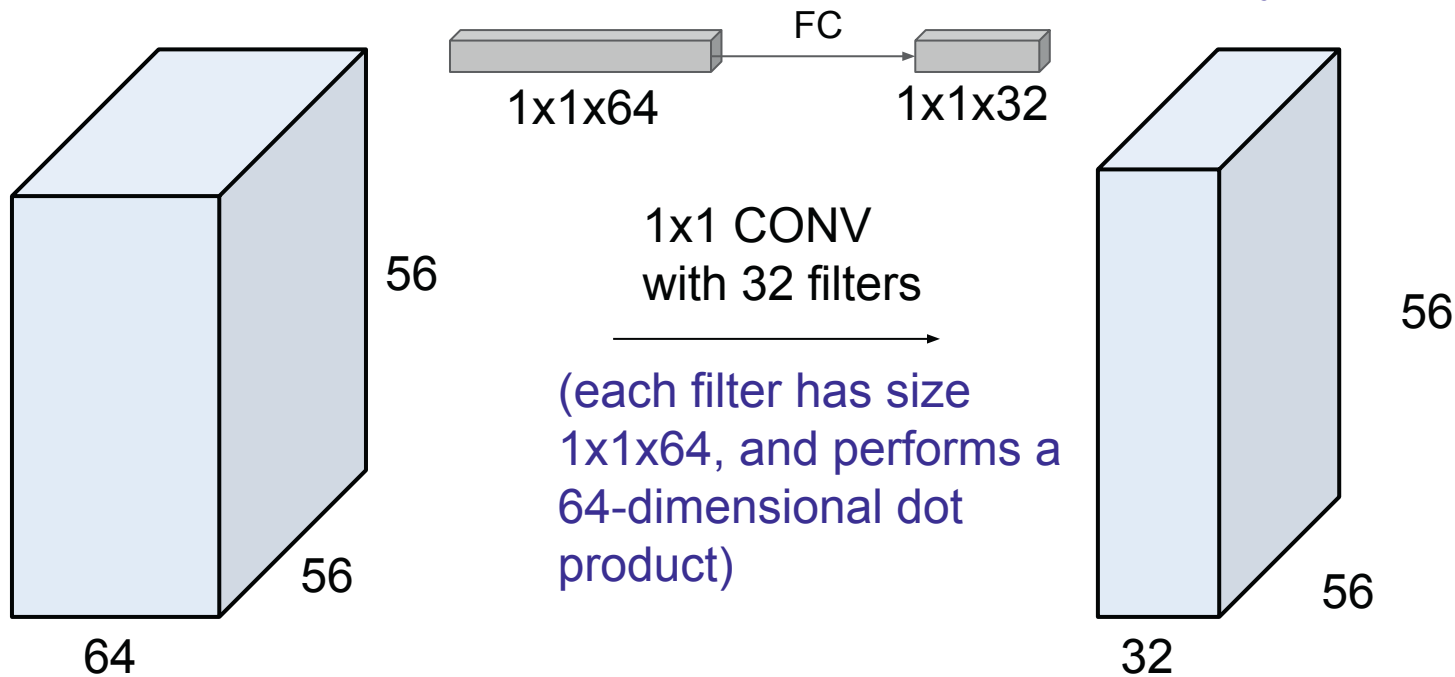

Review: 1x1 convolutions

Alternatively, interpret it as applying the same FC layer on each input pixel

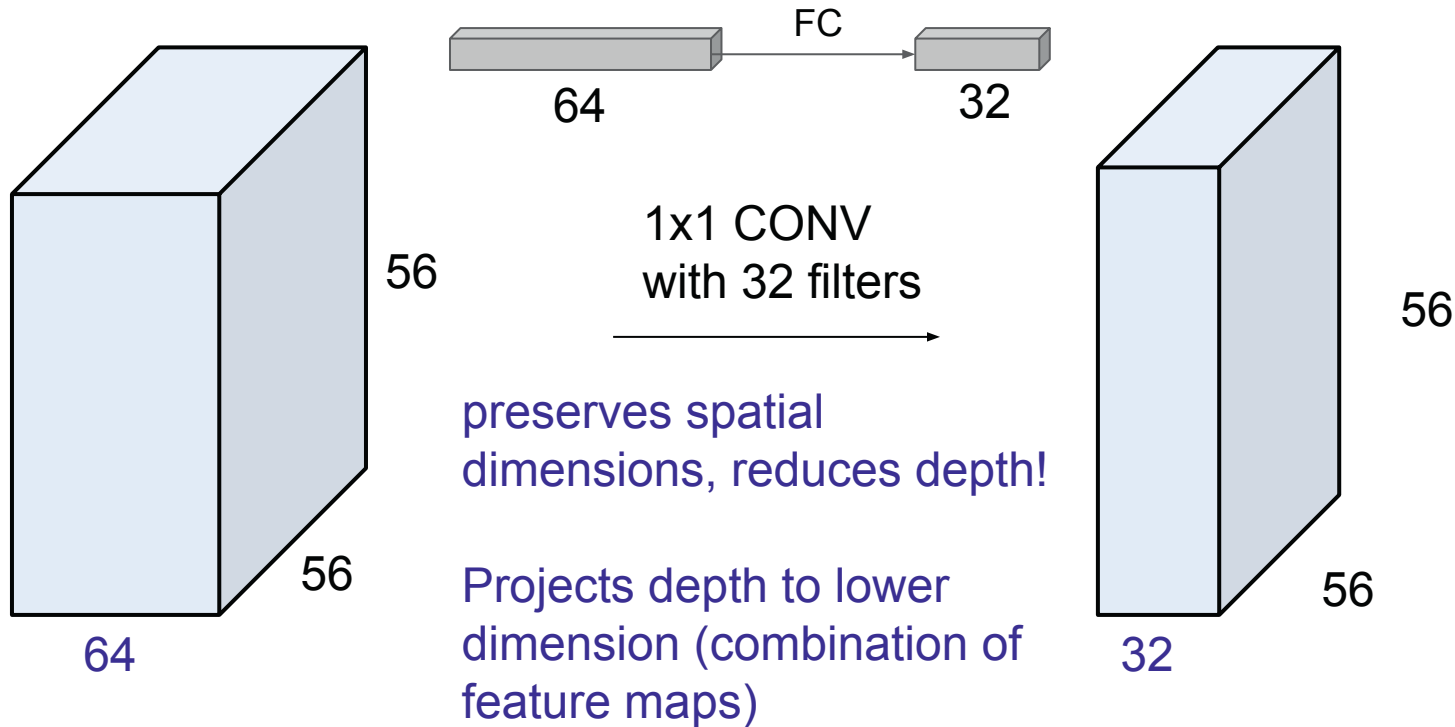

Case Study: GoogLeNet

[Szegedy et al., 2014]

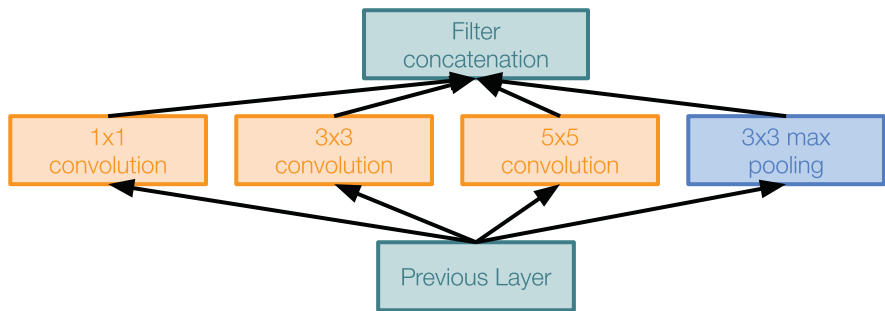

Naive Inception module

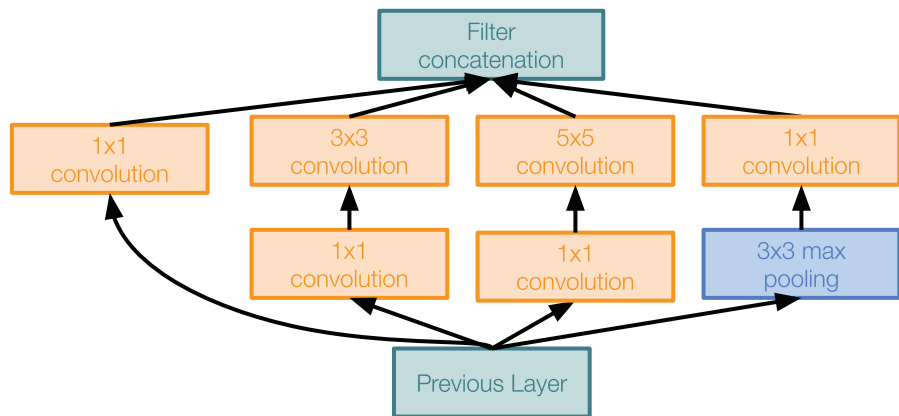

Inception module with dimension reduction

Case Study: GoogLeNet

[Szegedy et al., 2014]

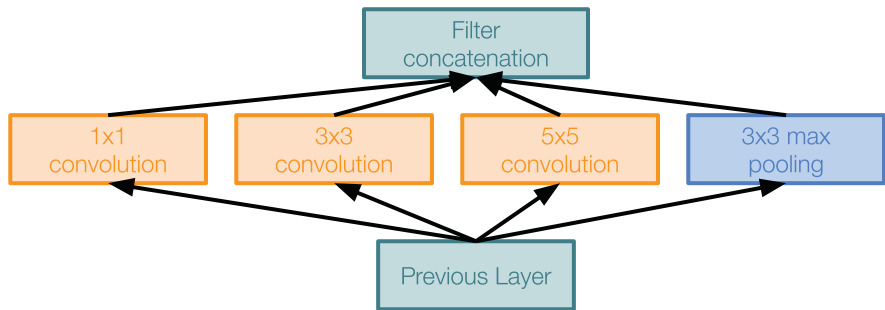

Naive Inception module

1x1 conv “bottleneck”
layers

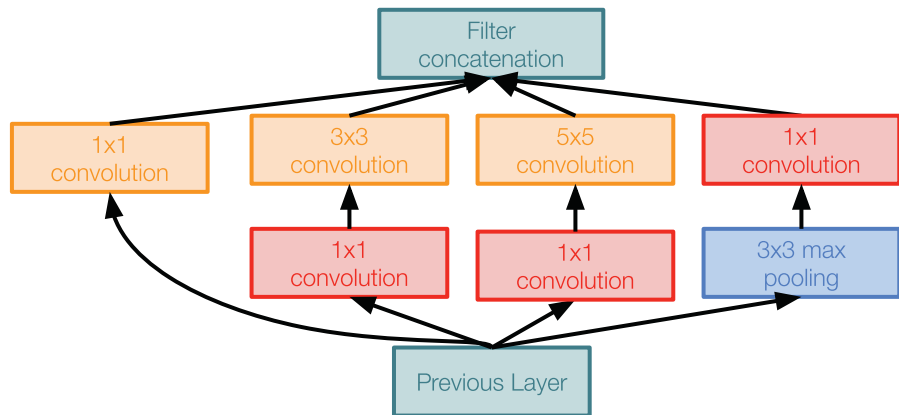

Inception module with dimension reduction

Case Study: GoogLeNet

[Szegedy et al., 2014]

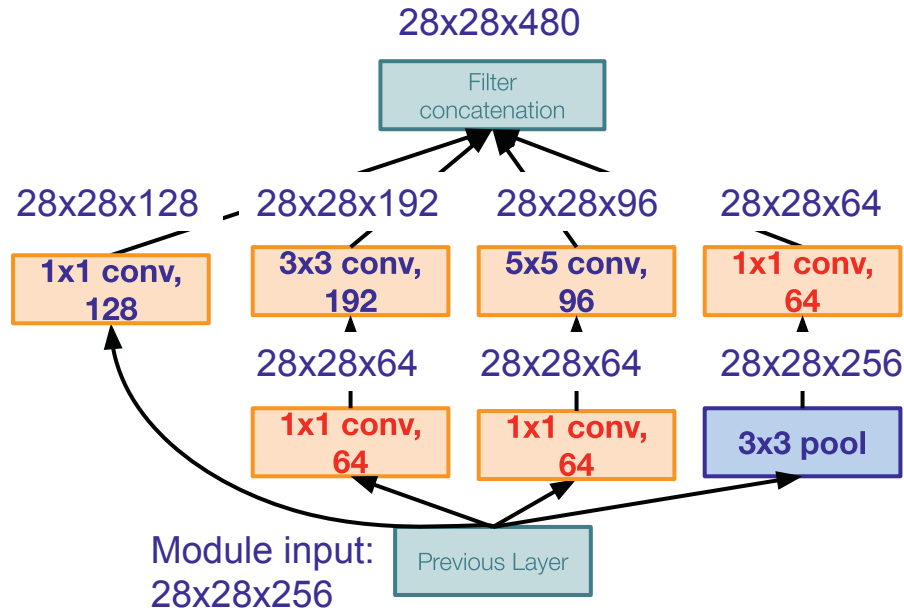

Inception module with dimension reduction

Using same parallel layers as naive example, and adding “1x1 conv, 64 filter” bottlenecks:

Conv Ops:

[1x1 conv, 64] 28x28x64x1x1x256
[1x1 conv, 64] 28x28x64x1x1x256
[1x1 conv, 128] 28x28x128x1x1x256
[3x3 conv, 192] 28x28x192x3x3x64
[5x5 conv, 96] 28x28x96x5x5x64
[1x1 conv, 64] 28x28x64x1x1x256

Total: 358M ops

Compared to 854M ops for naive version
Bottleneck can also reduce depth after pooling layer

Case Study: GoogLeNet

[Szegedy et al., 2014]

Stack Inception modules with dimension reduction on top of each other

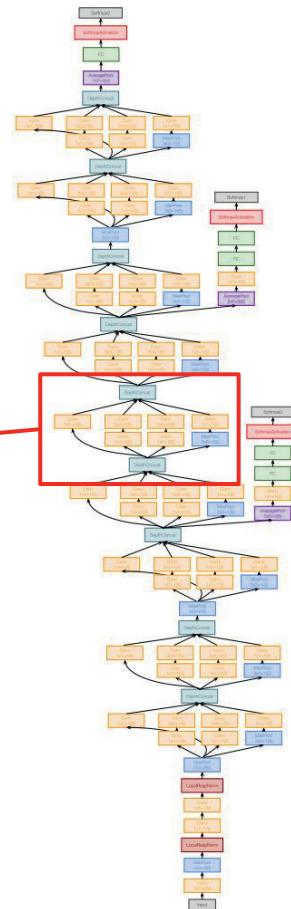
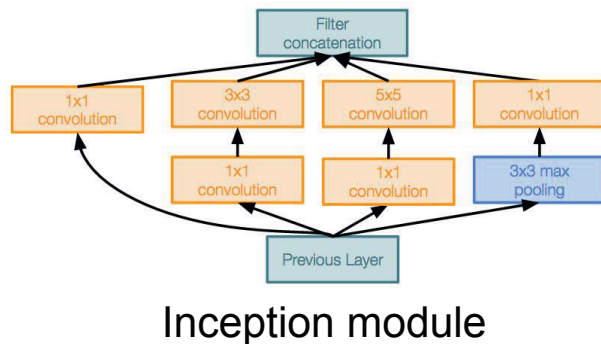

Case Study: GoogLeNet

[Szegedy et al., 2014]

Full GoogLeNet
architecture

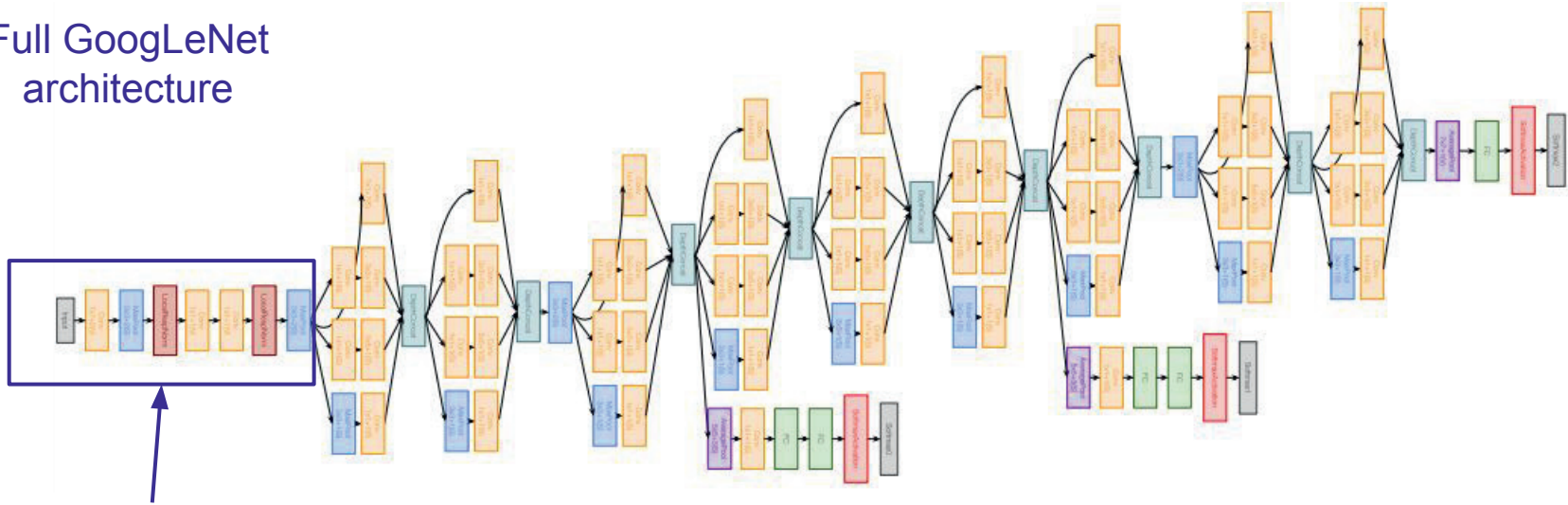

Stem Network:
Conv-Pool-
2x Conv-Pool

Case Study: GoogLeNet

[Szegedy et al., 2014]

Full GoogLeNet
architecture

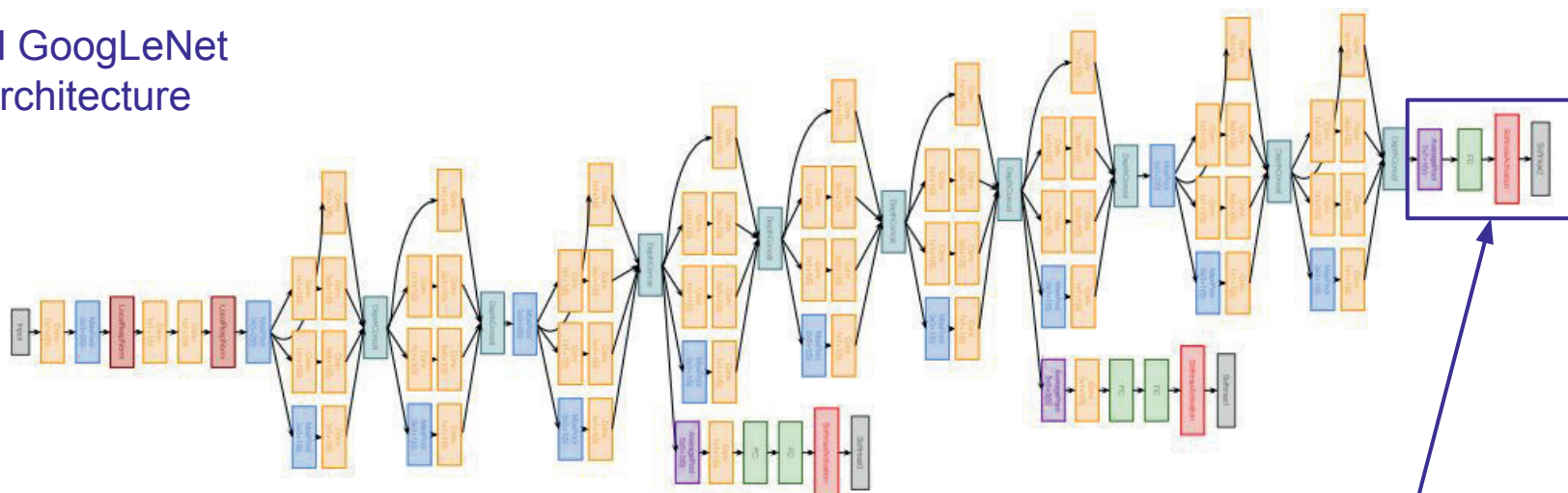

Classifier output

Case Study: GoogLeNet

[Szegedy et al., 2014]

Full GoogLeNet
architecture

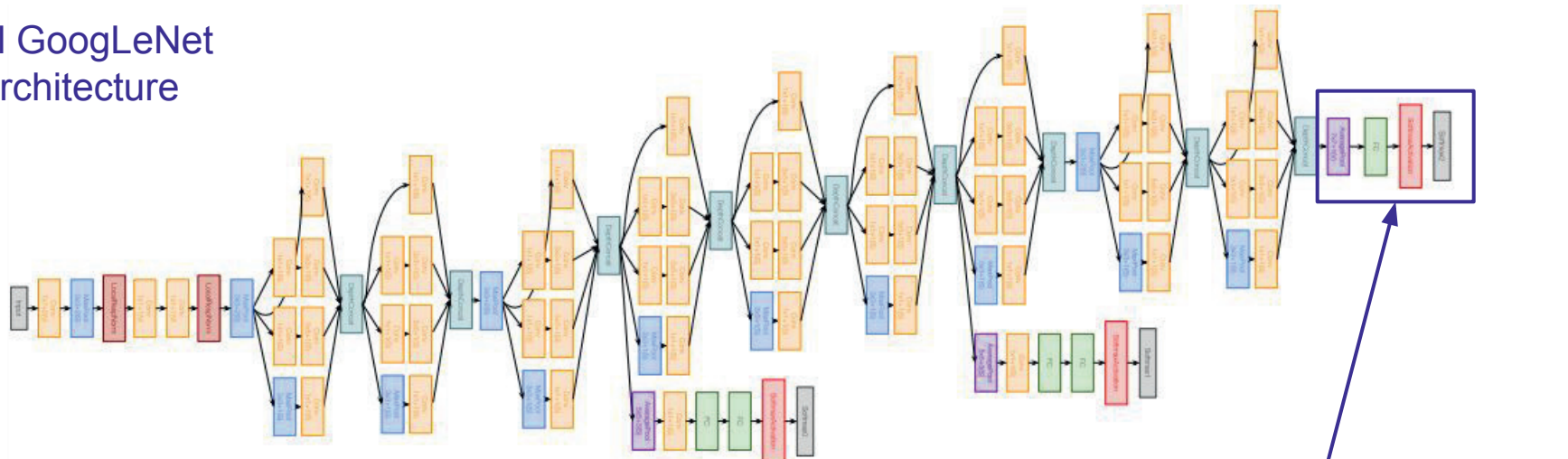

Note: after the last convolutional layer, a global average pooling layer is used that spatially averages across each feature map, before final FC layer. No longer multiple expensive FC layers!

Classifier output

Case Study: GoogLeNet

[Szegedy et al., 2014]

Full GoogLeNet
architecture

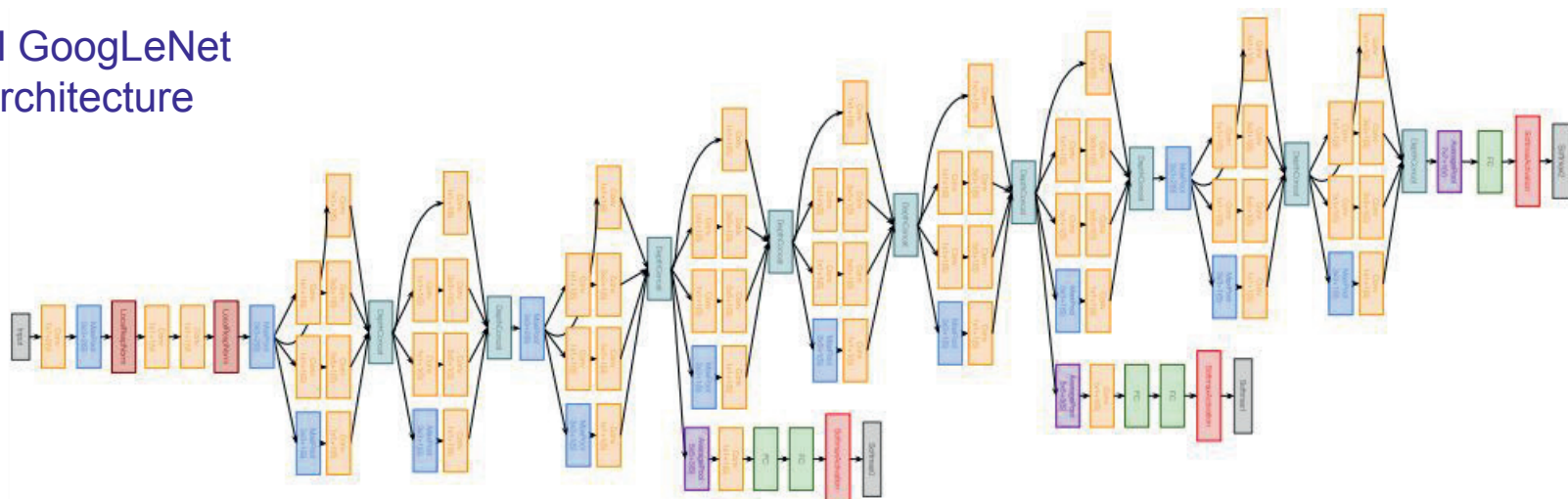

22 total layers with weights

(parallel layers count as 1 layer => 2 layers per Inception module. Don't count auxiliary output layers)

Case Study: GoogLeNet

[Szegedy et al., 2014]

Deeper networks, with computational efficiency

- 22 layers
- Efficient “Inception” module
- Avoids expensive FC layers
- 12x less params than AlexNet
- 27x less params than VGG-16
- ILSVRC’14 classification winner (6.7% top 5 error)

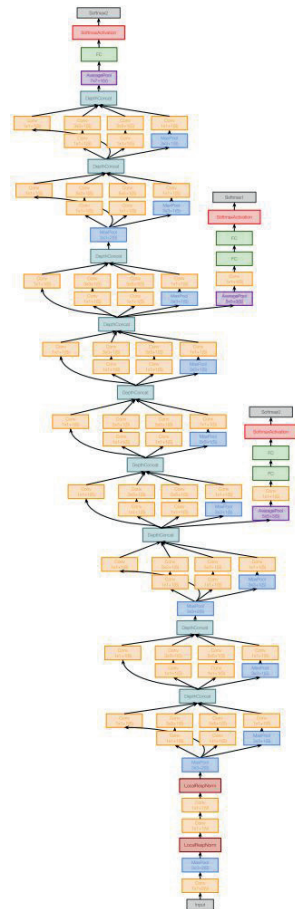
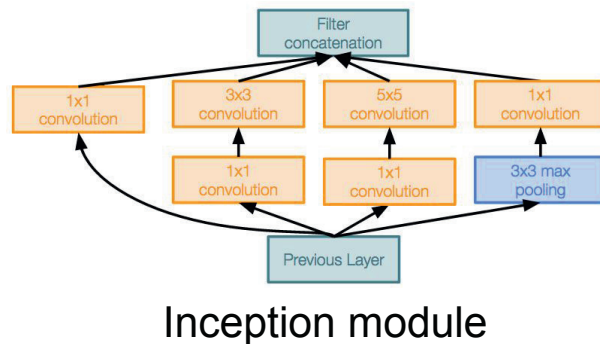

ImageNet Large Scale Visual Recognition Challenge (ILSVRC) winners

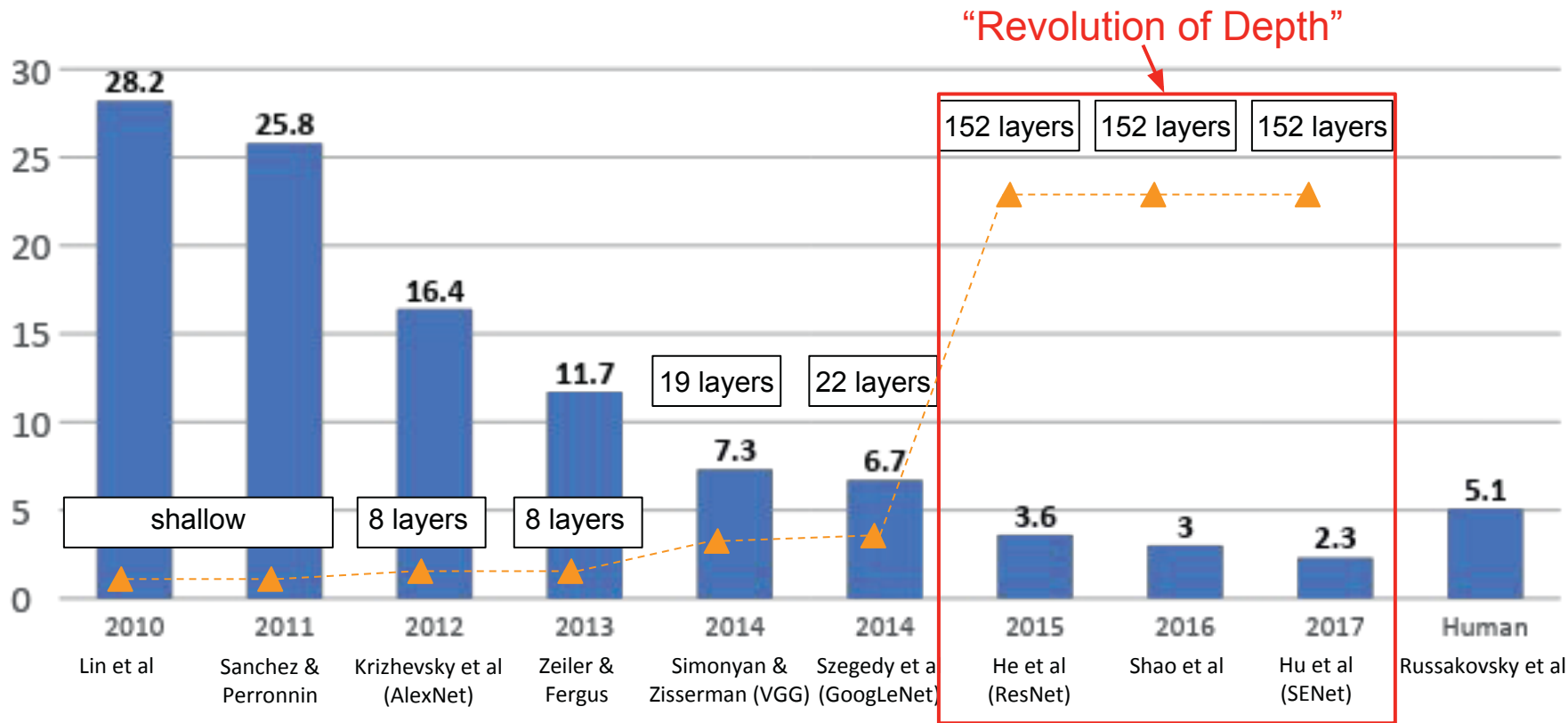

Case Study: ResNet

[He et al., 2015]

What happens when we continue stacking deeper layers on a “plain” convolutional neural network?

Case Study: ResNet

[He et al., 2015]

What happens when we continue stacking deeper layers on a “plain” convolutional neural network?

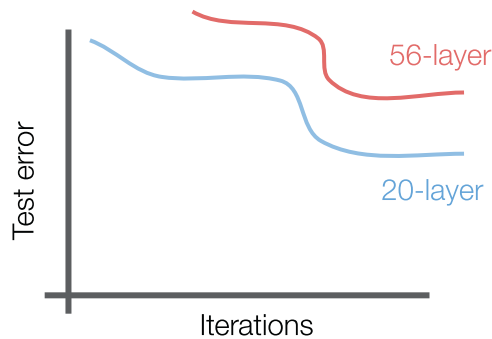
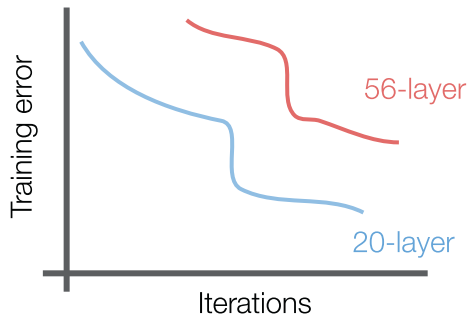

Case Study: ResNet

[He et al., 2015]

What happens when we continue stacking deeper layers on a “plain” convolutional neural network?

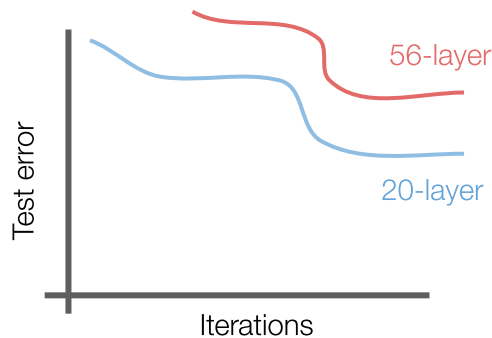
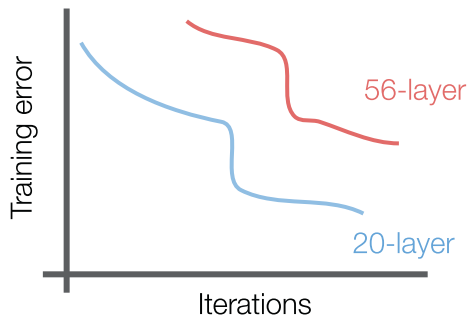

56-layer model performs worse on both training and test error

-> The deeper model performs worse, but it's **not caused by overfitting!**

Case Study: ResNet

[He et al., 2015]

Fact: Deep models have more representation power (more parameters) than shallower models.

Hypothesis: the problem is an *optimization* problem,
deeper models are harder to optimize

Case Study: ResNet

[He et al., 2015]

Fact: Deep models have more representation power (more parameters) than shallower models.

Hypothesis: the problem is an *optimization* problem, deeper models are harder to optimize

What should the deeper model learn to be at least as good as the shallower model?

A solution by construction is copying the learned layers from the shallower model and setting additional layers to identity mapping.

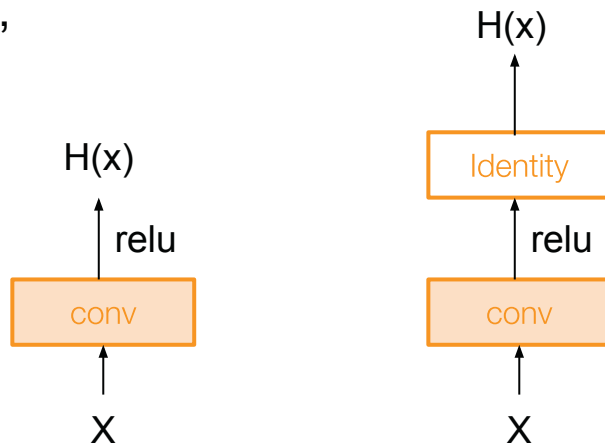

Case Study: ResNet

[He et al., 2015]

Solution: Use network layers to fit a residual mapping instead of directly trying to fit a desired underlying mapping

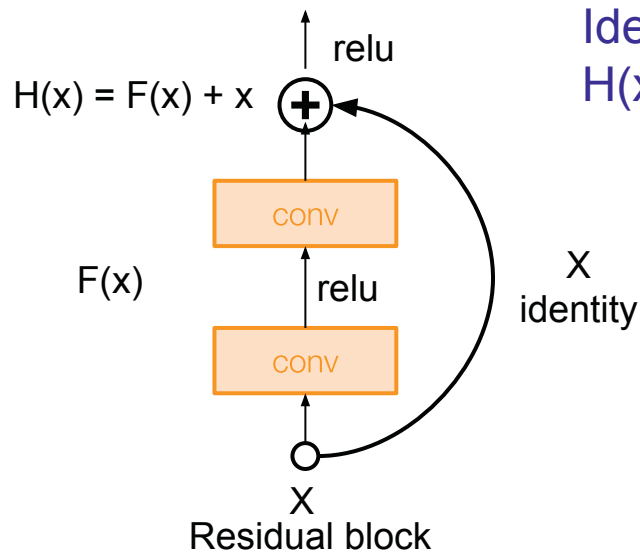
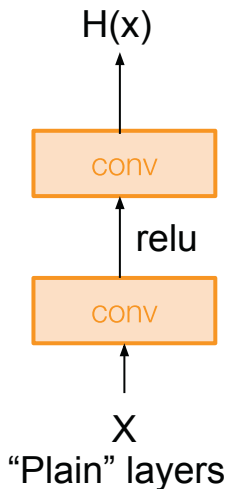

Identity mapping:
 $H(x) = x$ if $F(x) = 0$

Case Study: ResNet

[He et al., 2015]

Solution: Use network layers to fit a residual mapping instead of directly trying to fit a desired underlying mapping

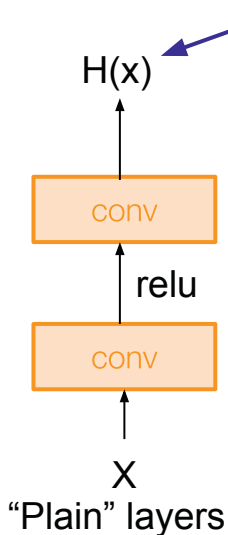

$$H(x) = F(x) + x$$

$$H(x) \equiv F(x) + x$$

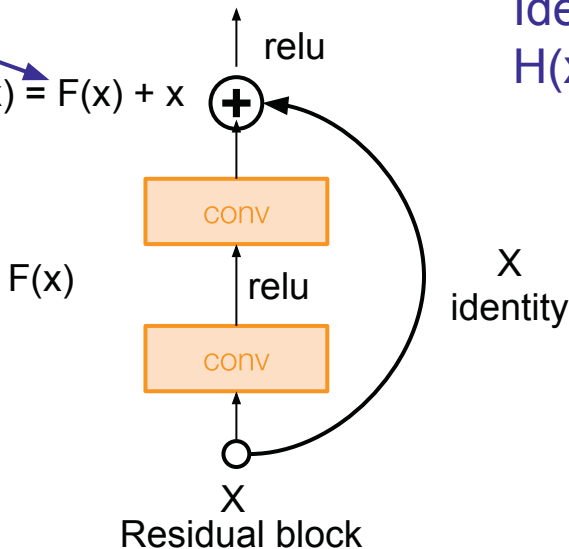

Identity mapping:
 $H(x) = x$ if $F(x) = 0$

Use layers to fit **residual**
 $F(x) = H(x) - x$
instead of
 $H(x)$ directly

Case Study: ResNet

[He et al., 2015]

Full ResNet architecture:

- Stack residual blocks
- Every residual block has two 3x3 conv layers

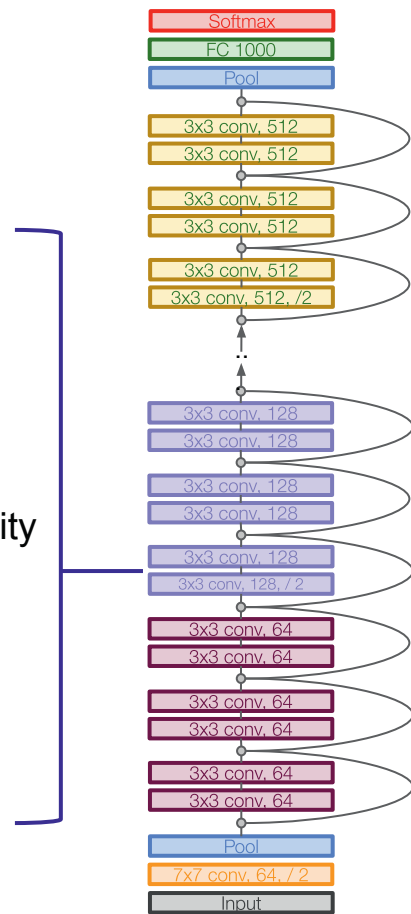
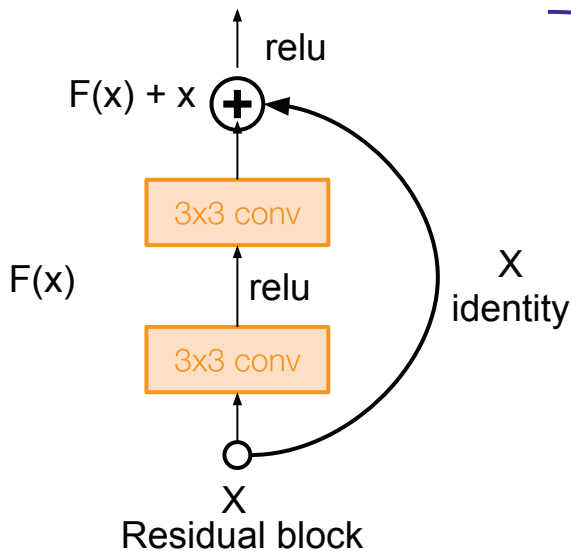

Case Study: ResNet

[He et al., 2015]

Full ResNet architecture:

- Stack residual blocks
- Every residual block has two 3x3 conv layers
- Periodically, double # of filters and downsample spatially using stride 2 (/2 in each dimension)
- Additional conv layer at the beginning (stem)

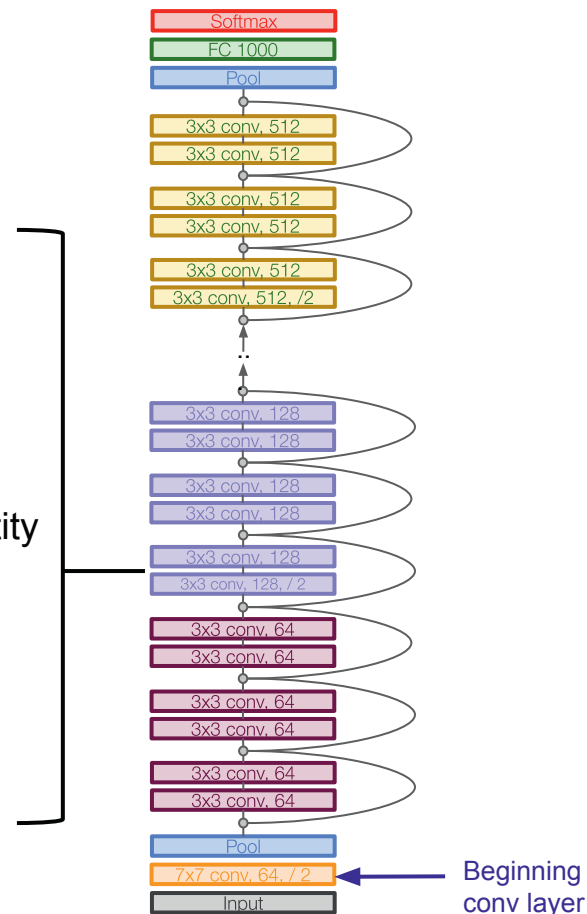
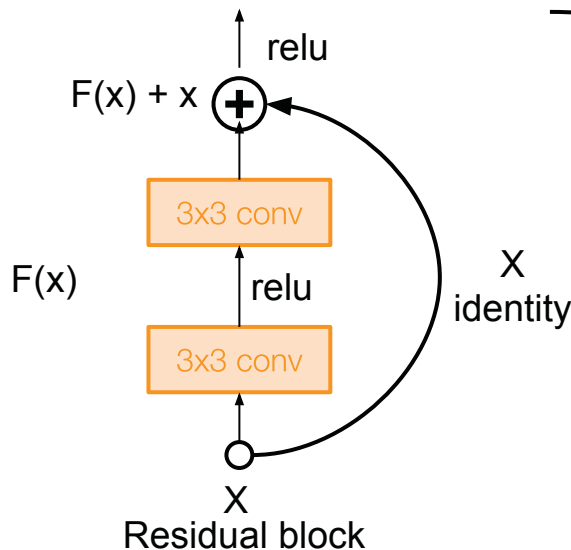

Case Study: ResNet

[He et al., 2015]

Total depths of 18, 34, 50,
101, or 152 layers for
ImageNet

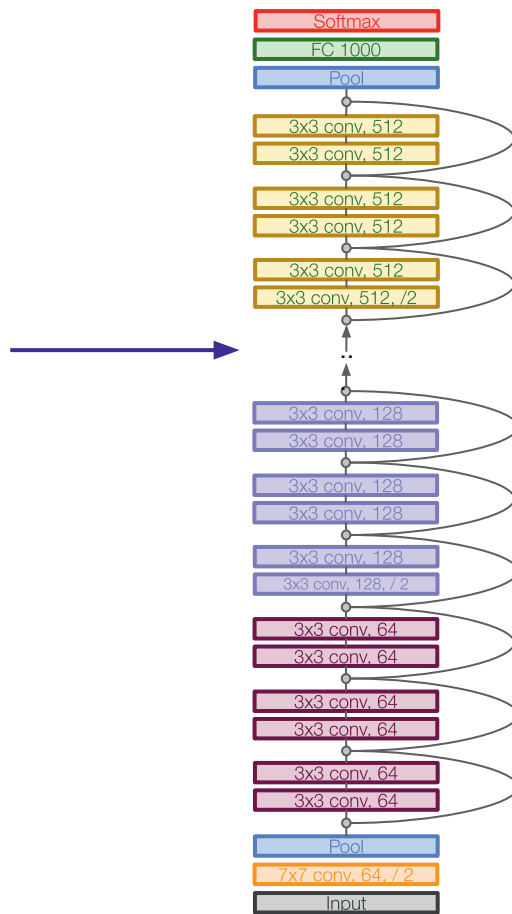

Case Study: ResNet

[He et al., 2015]

For deeper networks
(ResNet-50+), use “bottleneck”
layer to improve efficiency
(similar to GoogLeNet)

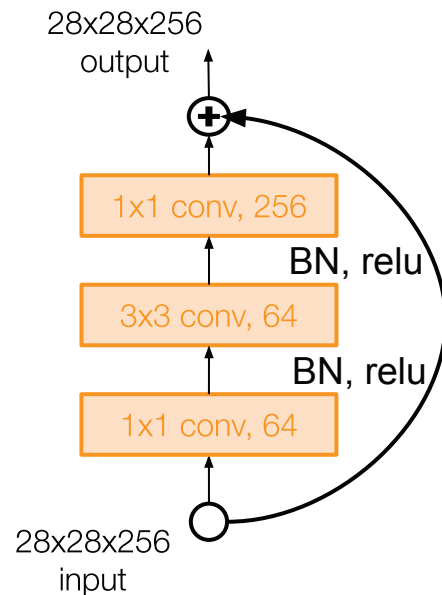

Case Study: ResNet

[He et al., 2015]

For deeper networks
(ResNet-50+), use “bottleneck”
layer to improve efficiency
(similar to GoogLeNet)

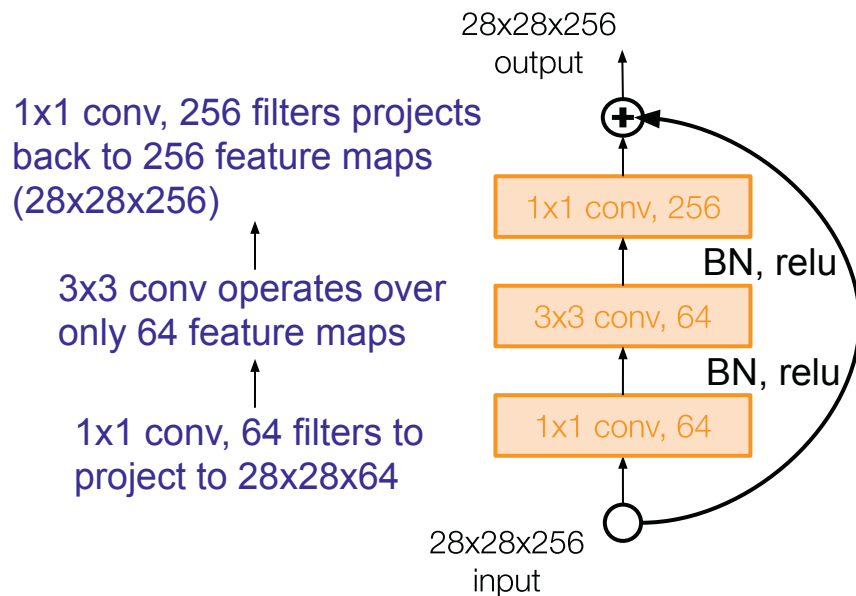

Case Study: ResNet

[He et al., 2015]

Training ResNet in practice:

- Batch Normalization after every CONV layer
- Xavier initialization from He et al.
- SGD + Momentum (0.9)
- Learning rate: 0.1, divided by 10 when validation error plateaus
- Mini-batch size 256
- Weight decay of $1e-5$
- No dropout used

Case Study: ResNet

[He et al., 2015]

Experimental Results

- Able to train very deep networks without degrading (152 layers on ImageNet, 1202 on Cifar)
- Deeper networks now achieve lower training error as expected
- Swept 1st place in all ILSVRC and COCO 2015 competitions

MSRA @ ILSVRC & COCO 2015 Competitions

• 1st places in all five main tracks

- ImageNet Classification: “Ultra-deep” (quote Yann) 152-layer nets
- ImageNet Detection: 16% better than 2nd
- ImageNet Localization: 27% better than 2nd
- COCO Detection: 11% better than 2nd
- COCO Segmentation: 12% better than 2nd

Case Study: ResNet

[He et al., 2015]

Experimental Results

- Able to train very deep networks without degrading (152 layers on ImageNet, 1202 on Cifar)
- Deeper networks now achieve lower training error as expected
- Swept 1st place in all ILSVRC and COCO 2015 competitions

MSRA @ ILSVRC & COCO 2015 Competitions

• 1st places in all five main tracks

- ImageNet Classification: “Ultra-deep” (quote Yann) 152-layer nets
- ImageNet Detection: 16% better than 2nd
- ImageNet Localization: 27% better than 2nd
- COCO Detection: 11% better than 2nd
- COCO Segmentation: 12% better than 2nd

ILSVRC 2015 classification winner (3.6% top 5 error) -- better than “human performance”! (Russakovsky 2014)

Comparing complexity...

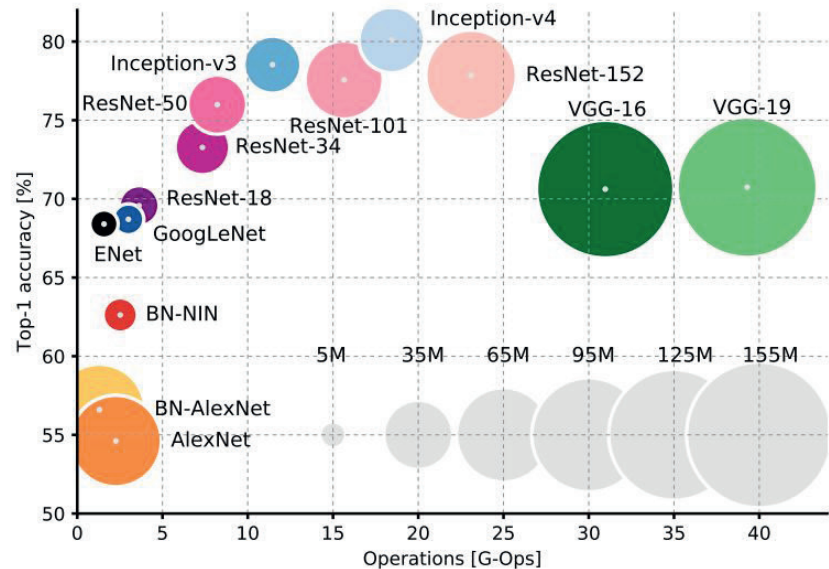
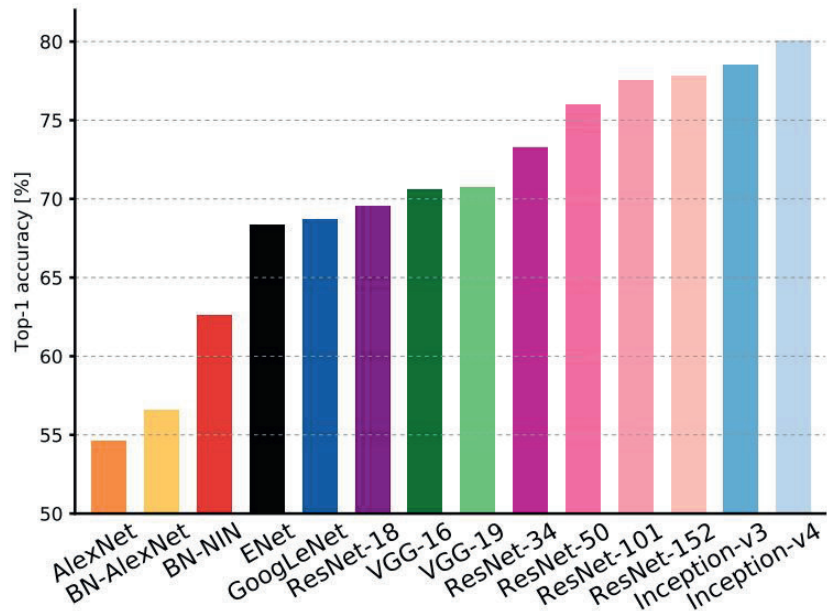

An Analysis of Deep Neural Network Models for Practical Applications, 2017.

Figures copyright Alfredo Canziani, Adam Paszke, Eugenio Culurciello, 2017. Reproduced with permission.

Comparing complexity...

Inception-v4: Resnet + Inception!

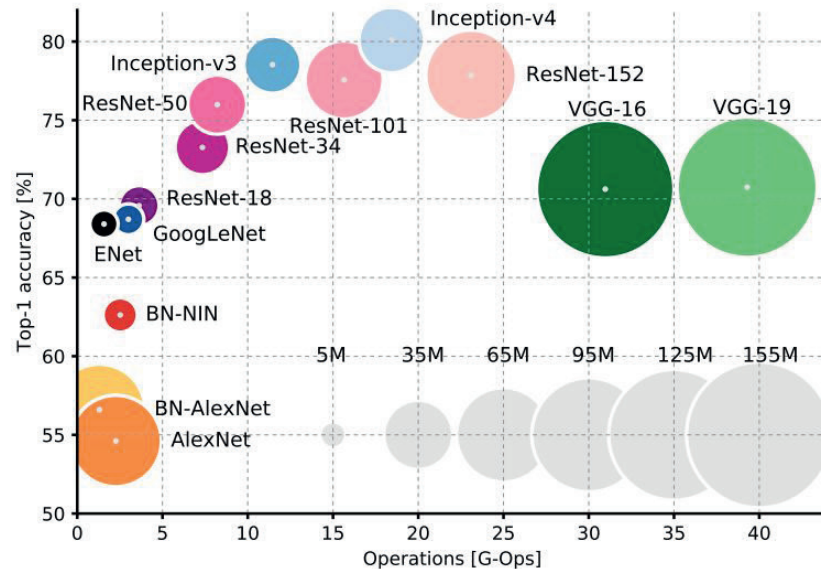
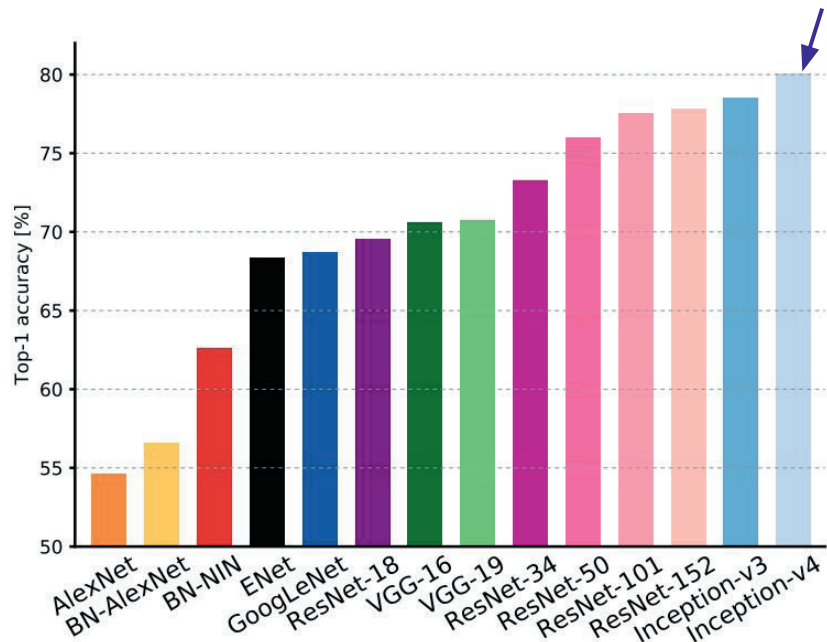

An Analysis of Deep Neural Network Models for Practical Applications, 2017.

Figures copyright Alfredo Canziani, Adam Paszke, Eugenio Culurciello, 2017. Reproduced with permission.

Comparing complexity...

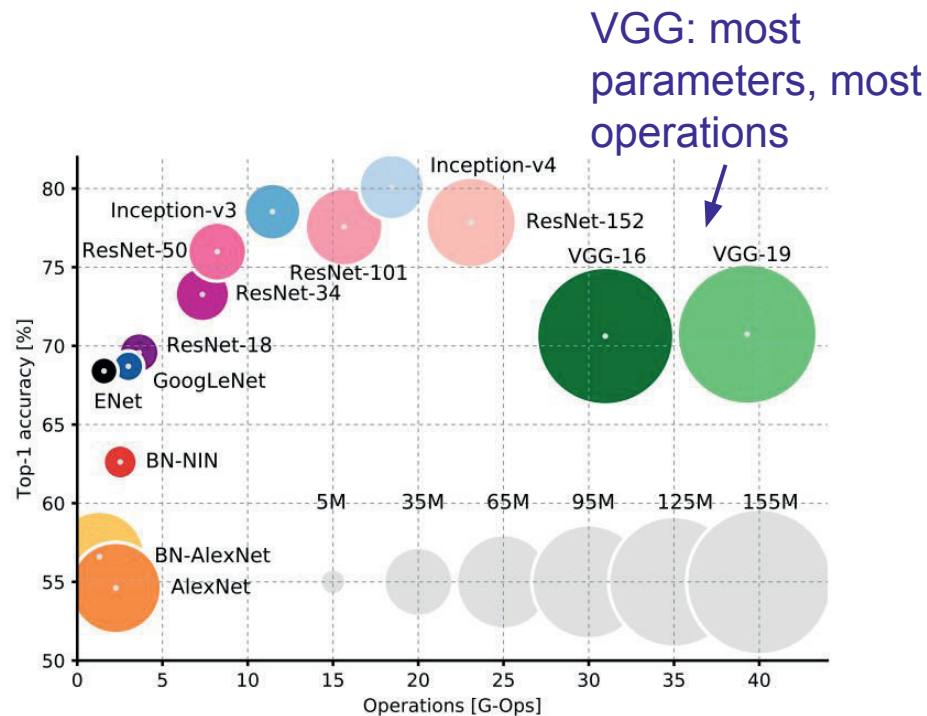
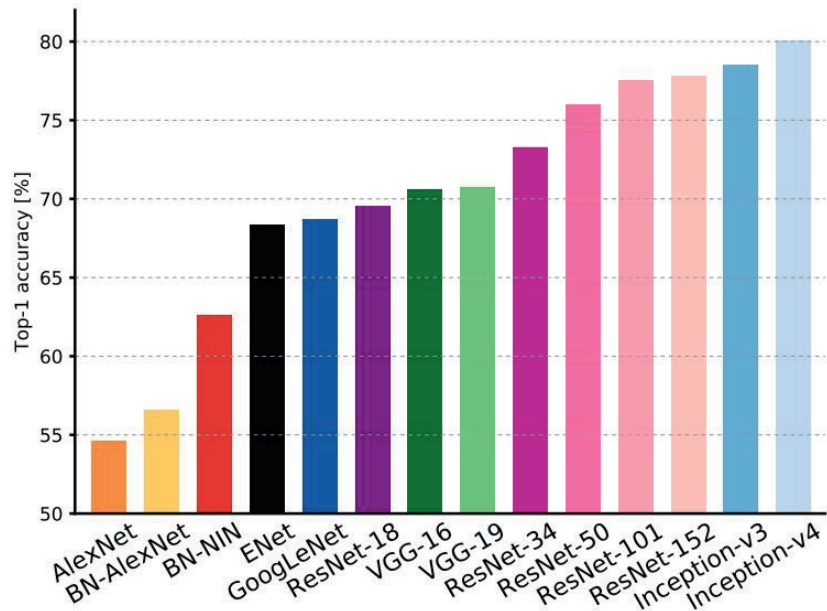

An Analysis of Deep Neural Network Models for Practical Applications, 2017.

Figures copyright Alfredo Canziani, Adam Paszke, Eugenio Culurciello, 2017. Reproduced with permission.

Comparing complexity...

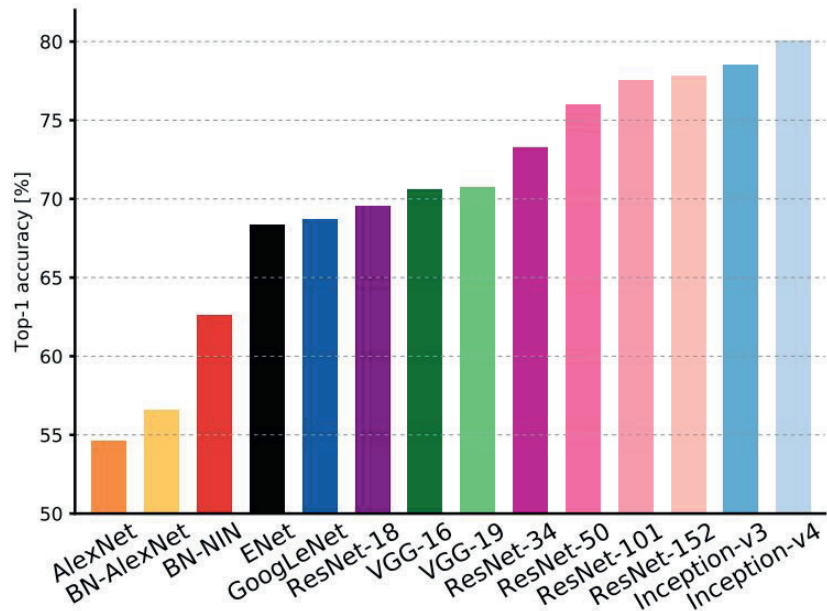

GoogLeNet:
most efficient

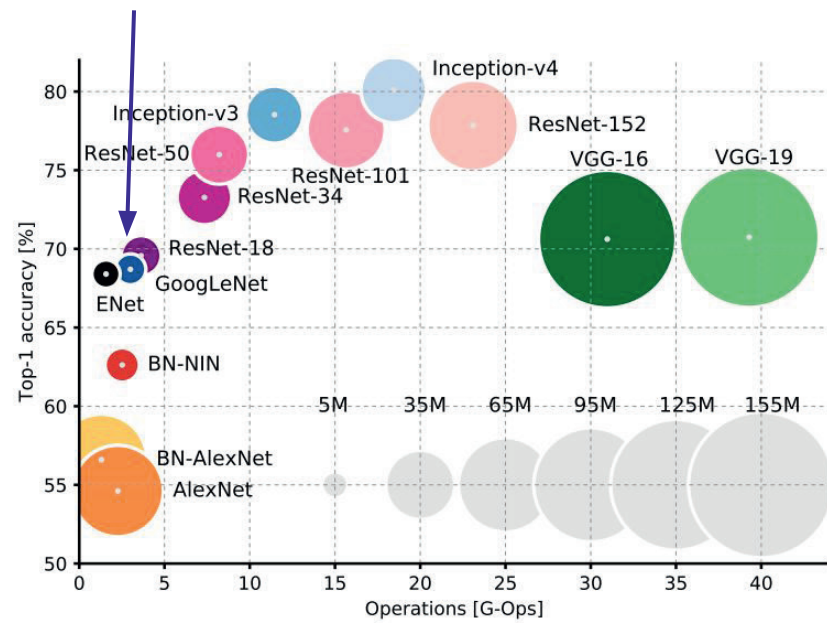

An Analysis of Deep Neural Network Models for Practical Applications, 2017.

Figures copyright Alfredo Canziani, Adam Paszke, Eugenio Culurciello, 2017. Reproduced with permission.

Comparing complexity...

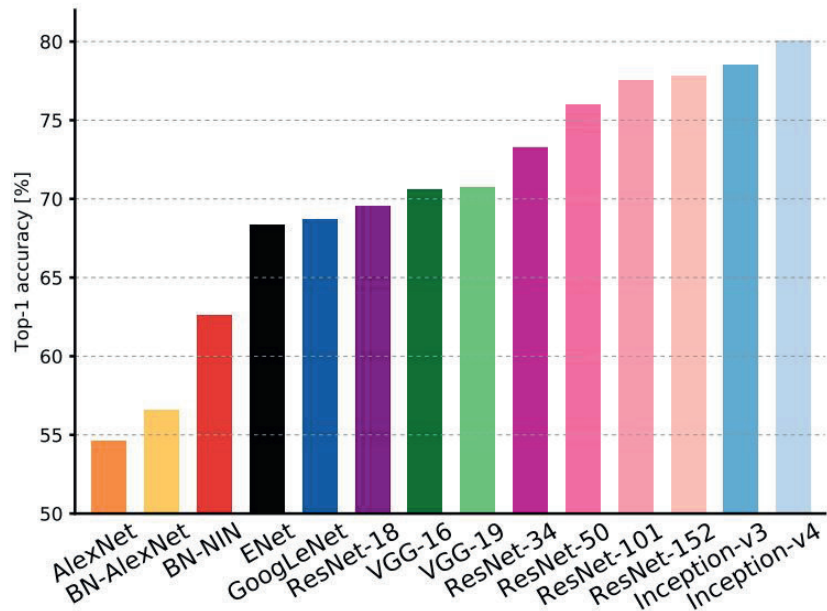

AlexNet:
Smaller compute, still memory heavy, lower accuracy

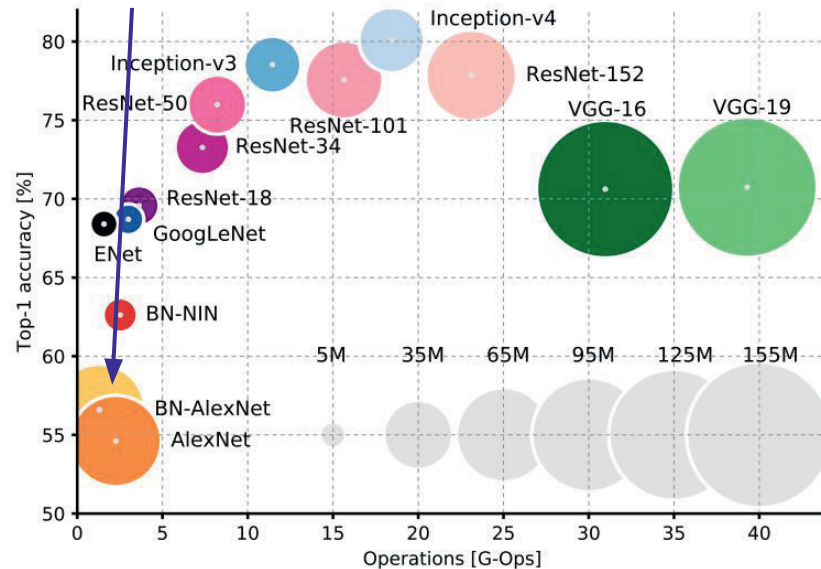

An Analysis of Deep Neural Network Models for Practical Applications, 2017.

Figures copyright Alfredo Canziani, Adam Paszke, Eugenio Culurciello, 2017. Reproduced with permission.

Comparing complexity...

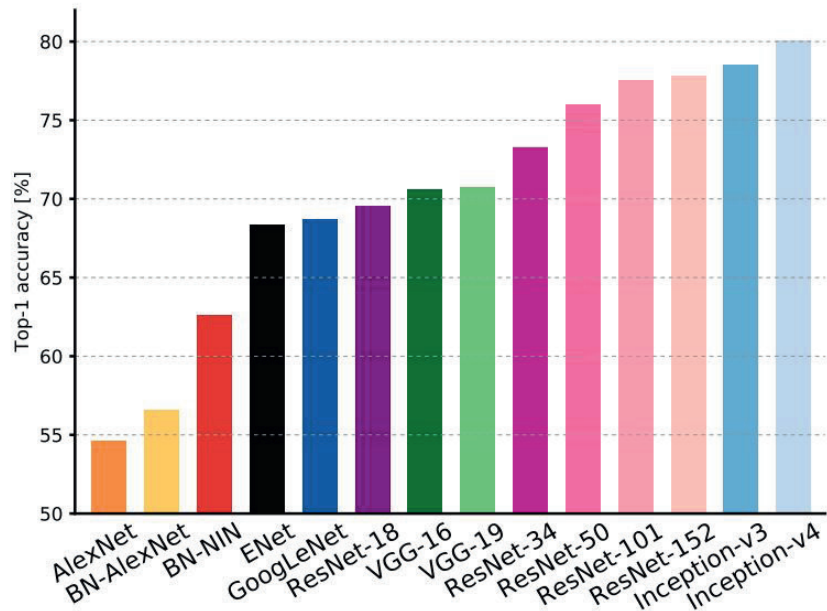

ResNet:
Moderate efficiency depending on
model, highest accuracy

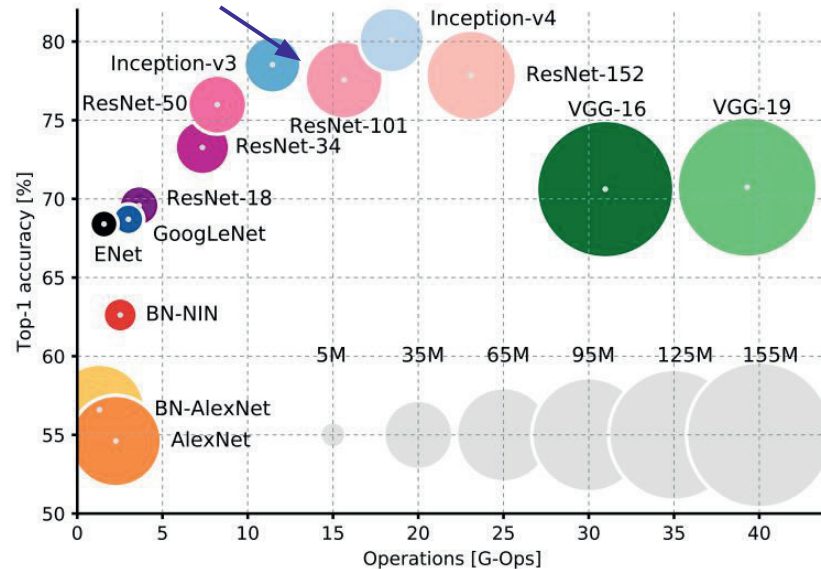

An Analysis of Deep Neural Network Models for Practical Applications, 2017.

Figures copyright Alfredo Canziani, Adam Paszke, Eugenio Culurciello, 2017. Reproduced with permission.

ImageNet Large Scale Visual Recognition Challenge (ILSVRC) winners

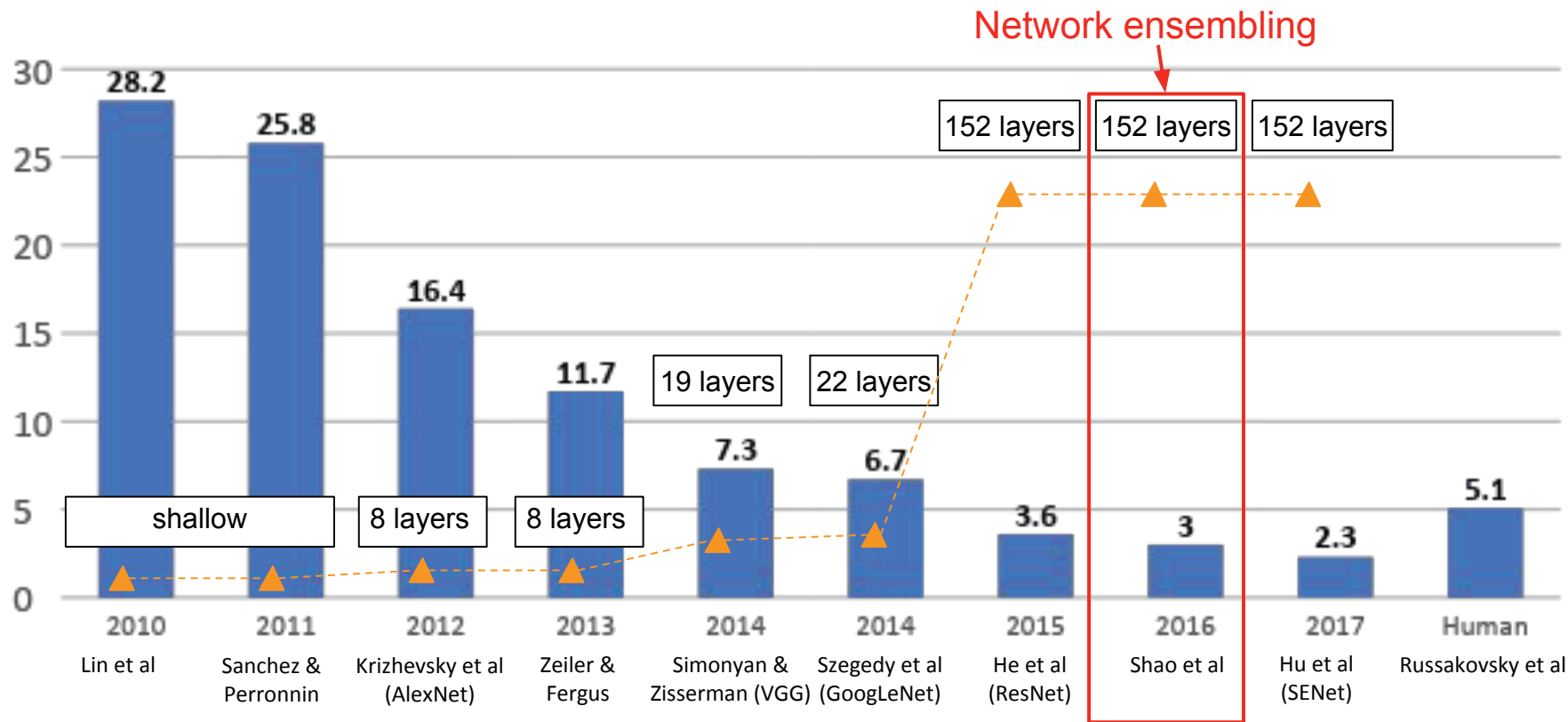

Improving ResNets...

“Good Practices for Deep Feature Fusion”

[Shao et al. 2016]

- Multi-scale ensembling of Inception, Inception-Resnet, Resnet, Wide Resnet models
- ILSVRC'16 classification winner

	Inception-v3	Inception-v4	Inception-Resnet-v2	Resnet-200	Wrn-68-3	Fusion (Val.)	Fusion (Test)
Err. (%)	4.20	4.01	3.52	4.26	4.65	2.92 (-0.6)	2.99

ImageNet Large Scale Visual Recognition Challenge (ILSVRC) winners

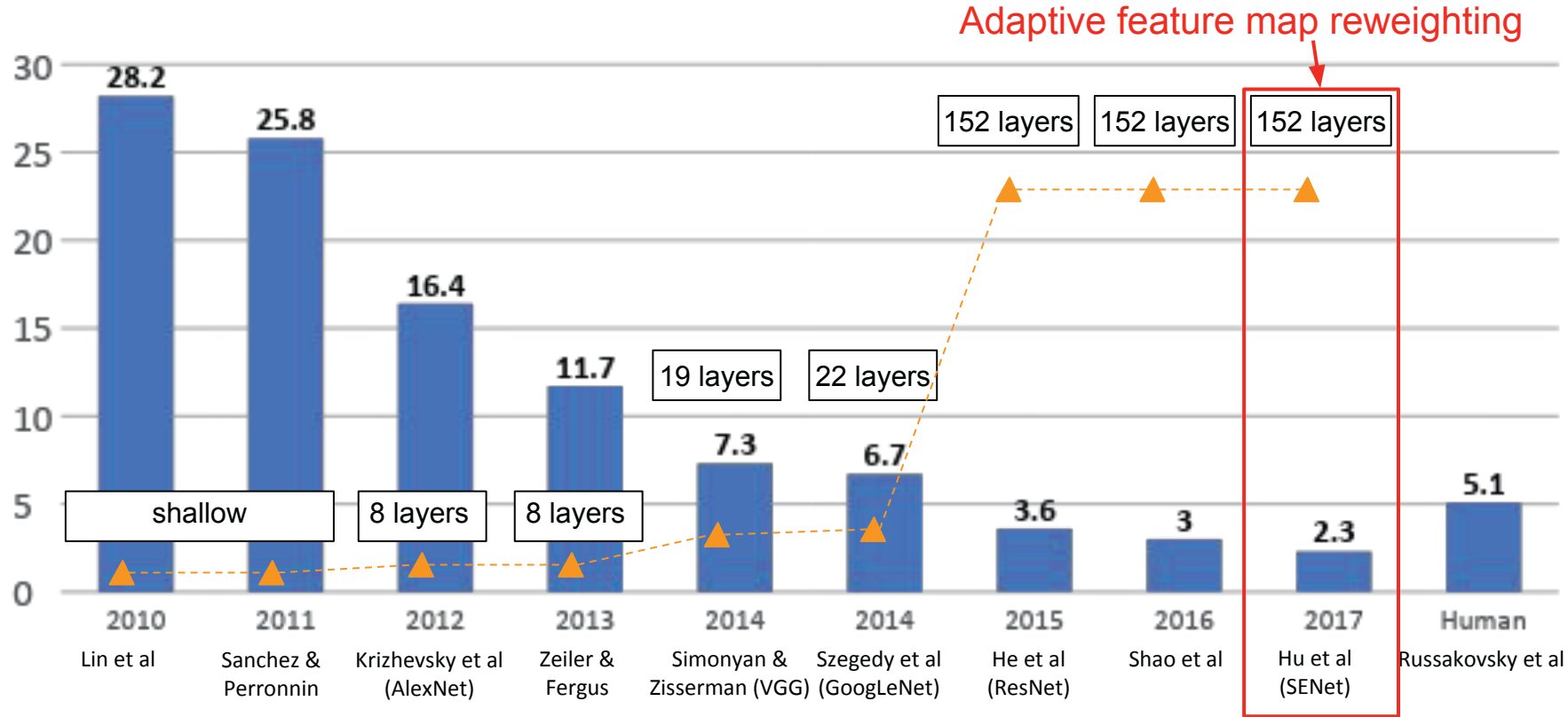

Improving ResNets...

Squeeze-and-Excitation Networks (SENet)

[Hu et al. 2017]

- Add a “feature recalibration” module that learns to adaptively reweight feature maps
- Global information (global avg. pooling layer) + 2 FC layers used to determine feature map weights
- ILSVRC'17 classification winner (using ResNeXt-152 as a base architecture)

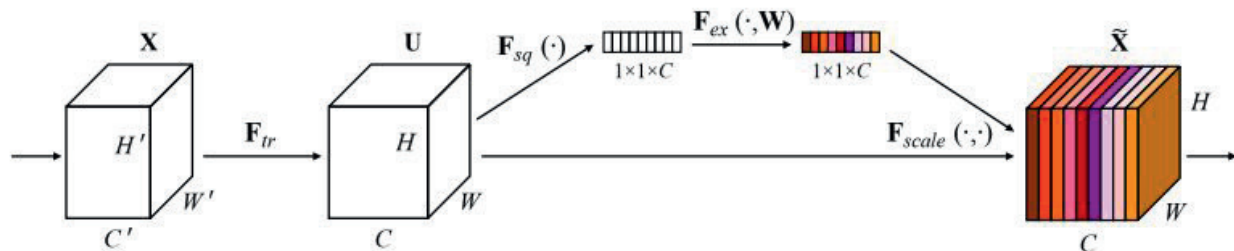
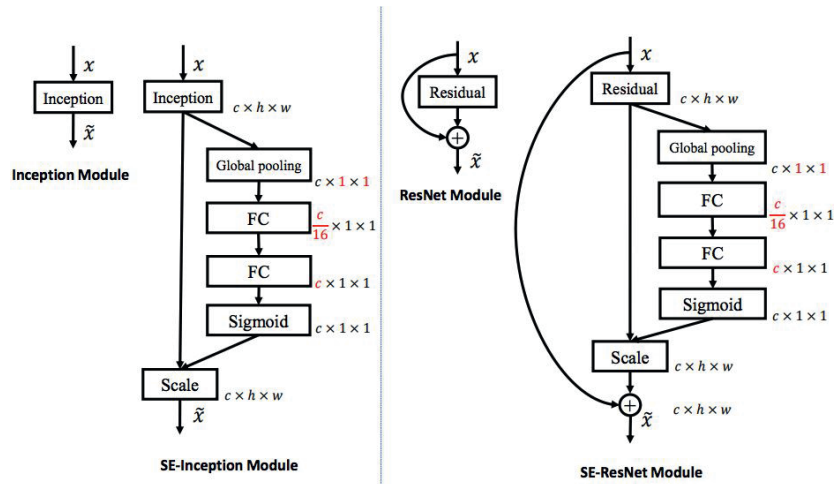

ImageNet Large Scale Visual Recognition Challenge (ILSVRC) winners

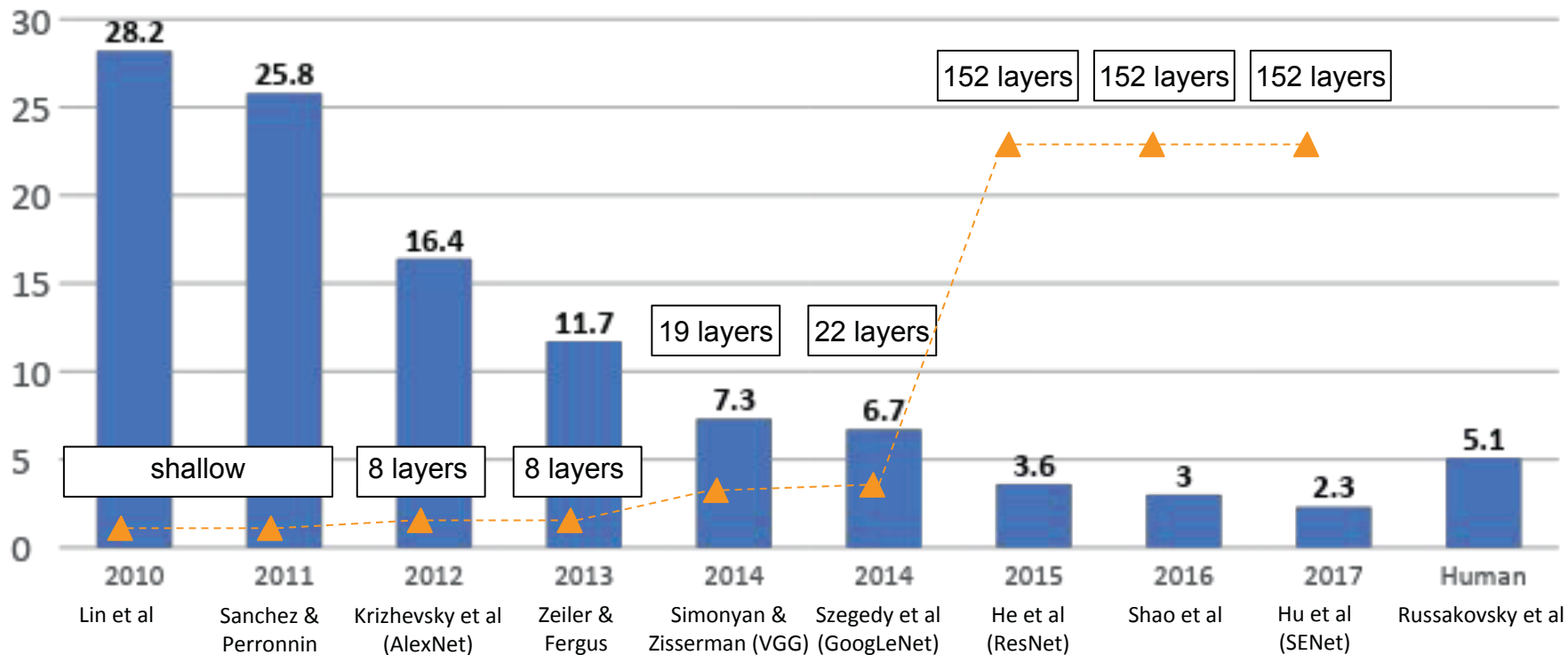

ImageNet Large Scale Visual Recognition Challenge (ILSVRC) winners

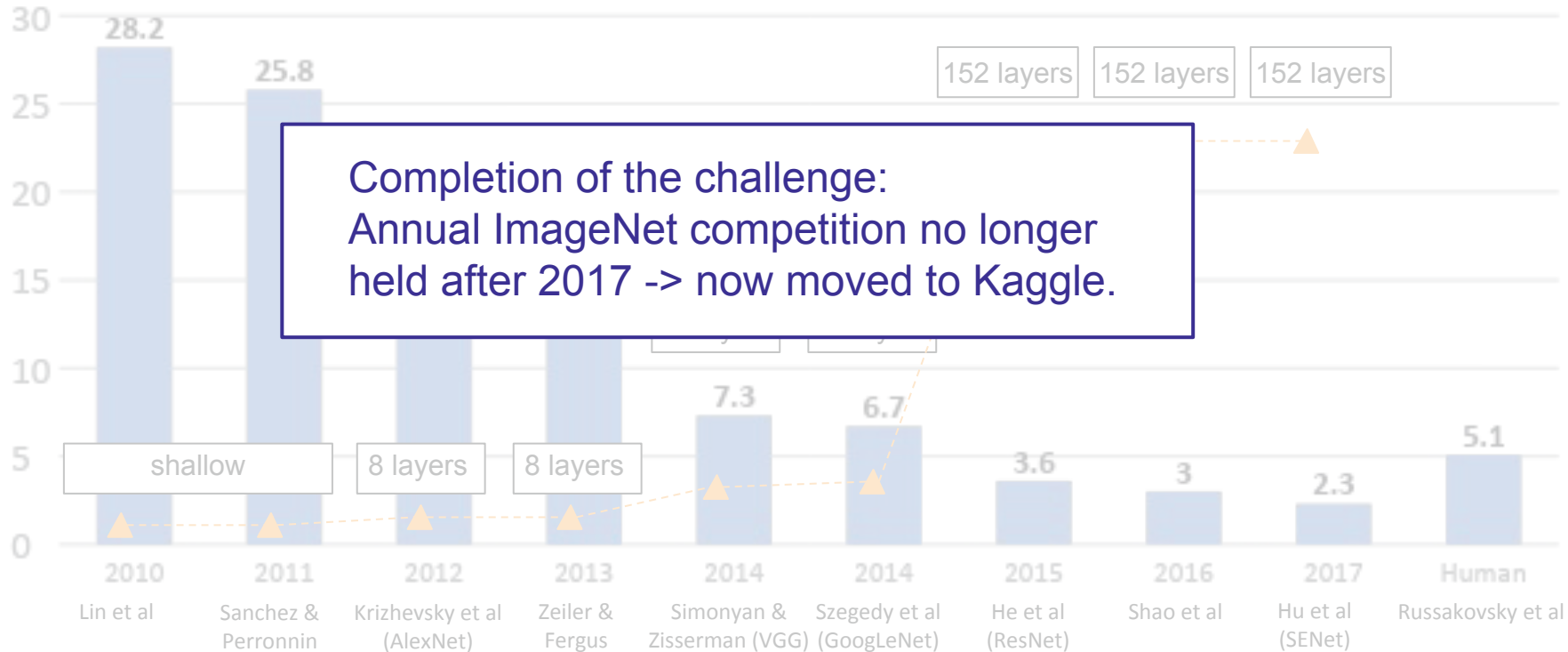

But research into CNN architectures is still flourishing

Improving ResNets...

Identity Mappings in Deep Residual Networks

[He et al. 2016]

- Improved ResNet block design from creators of ResNet
- Creates a more direct path for propagating information throughout network
- Gives better performance

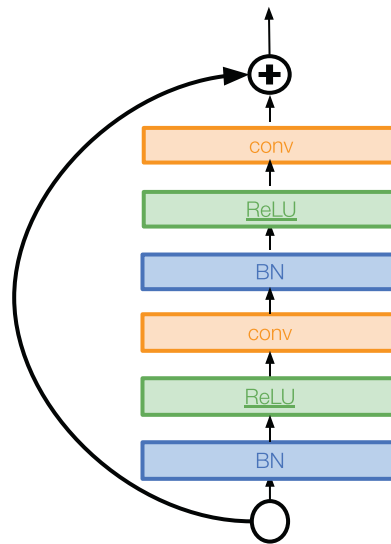

Improving ResNets...

Wide Residual Networks

[Zagoruyko et al. 2016]

- Argues that residuals are the important factor, not depth
- Use wider residual blocks ($F \times k$ filters instead of F filters in each layer)
- 50-layer wide ResNet outperforms 152-layer original ResNet
- Increasing width instead of depth more computationally efficient (parallelizable)

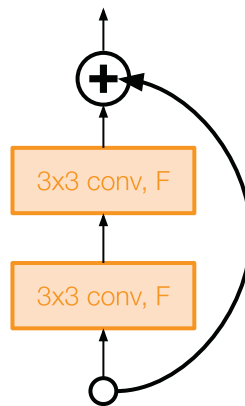

Basic residual block

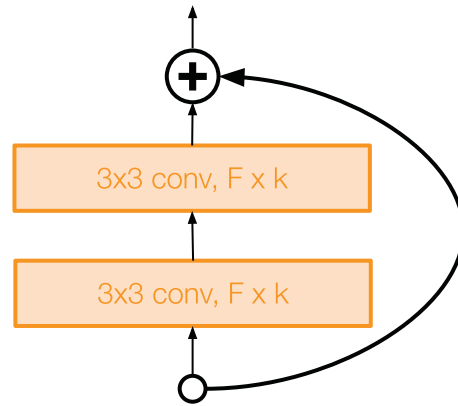

Wide residual block

Improving ResNets...

Aggregated Residual Transformations for Deep Neural Networks (ResNeXt)

[Xie et al. 2016]

- Also from creators of ResNet
- Increases width of residual block through multiple parallel pathways (“cardinality”)
- Parallel pathways similar in spirit to Inception module

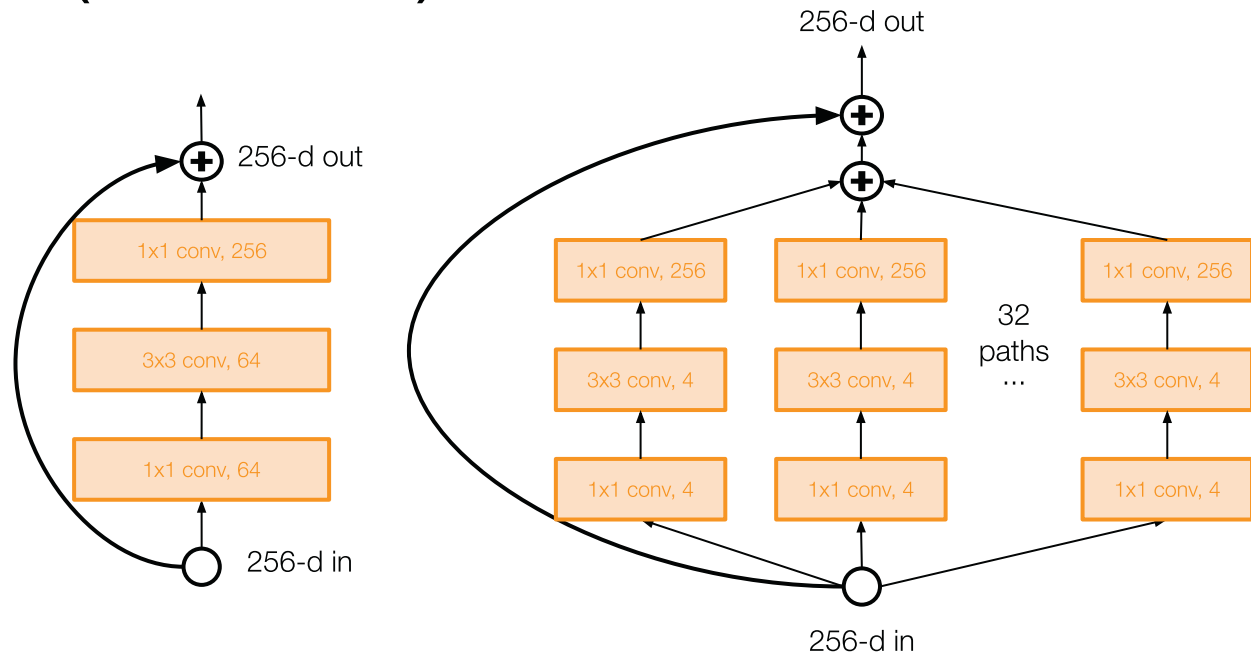

Other ideas...

Densely Connected Convolutional Networks (DenseNet)

[Huang et al. 2017]

- Dense blocks where each layer is connected to every other layer in feedforward fashion
- Alleviates vanishing gradient, strengthens feature propagation, encourages feature reuse
- Showed that shallow 50-layer network can outperform deeper 152 layer ResNet

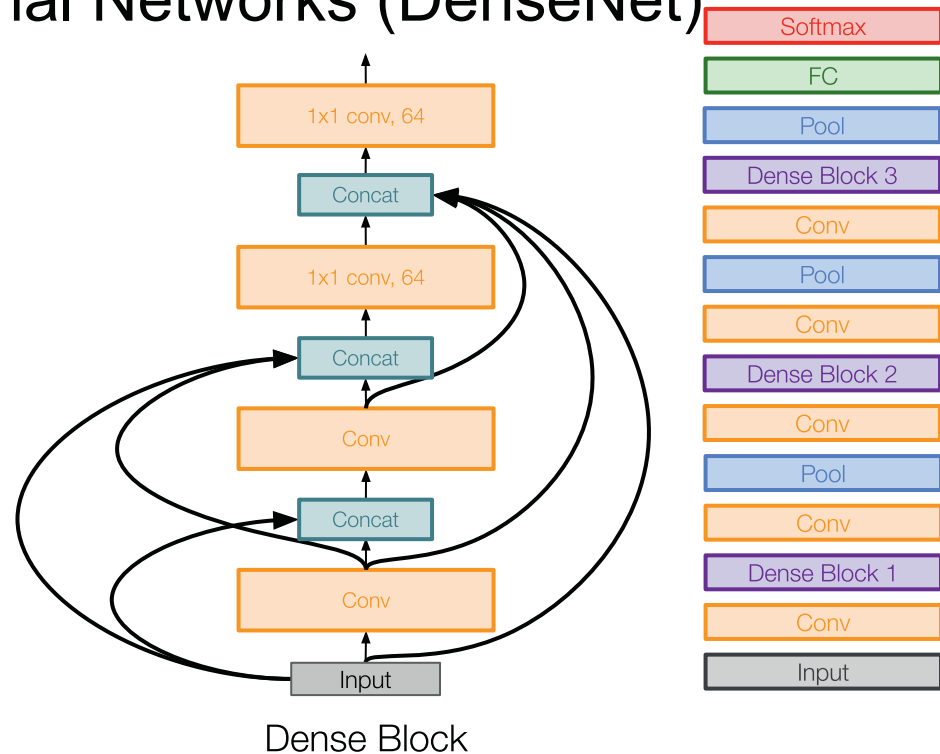

Efficient networks...

MobileNets: Efficient Convolutional Neural Networks for Mobile Applications [Howard et al. 2017]

- Depthwise separable convolutions replace standard convolutions by factorizing them into a depthwise convolution and a 1×1 convolution
- Much more efficient, with little loss in accuracy
- Follow-up MobileNetV2 work in 2018 (Sandler et al.)
- ShuffleNet: Zhang et al, CVPR 2018

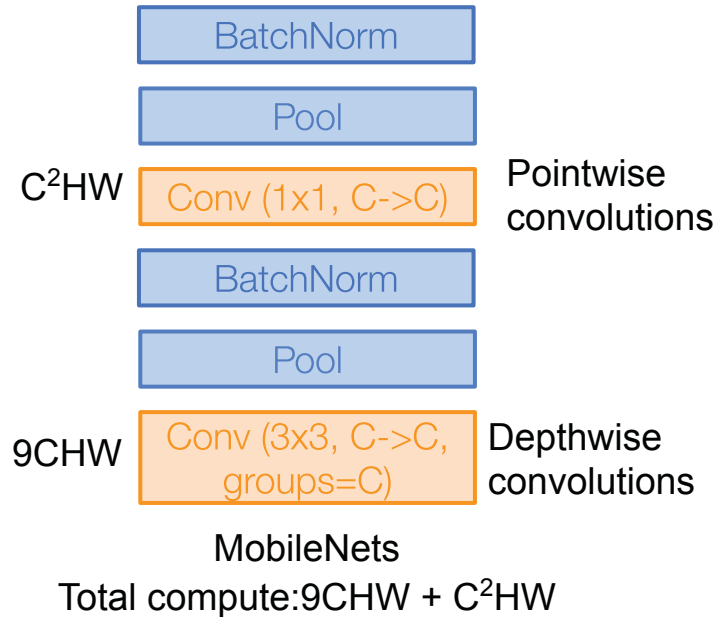
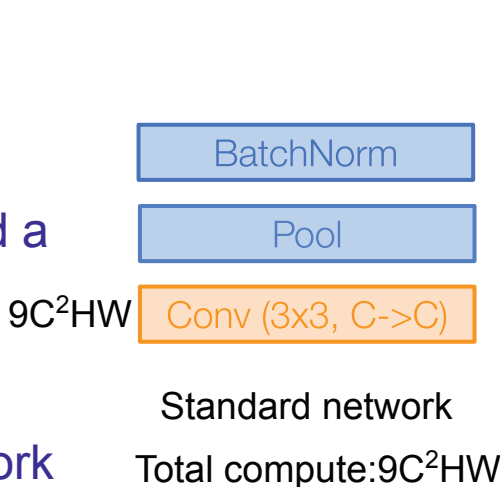

Learning to search for network architectures...

Neural Architecture Search with Reinforcement Learning (NAS)

[Zoph et al. 2016]

- “Controller” network that learns to design a good network architecture (output a string corresponding to network design)
- Iterate:
 - 1) Sample an architecture from search space
 - 2) Train the architecture to get a “reward” R corresponding to accuracy
 - 3) Compute gradient of sample probability, and scale by R to perform controller parameter update (i.e. increase likelihood of good architecture being sampled, decrease likelihood of bad architecture)

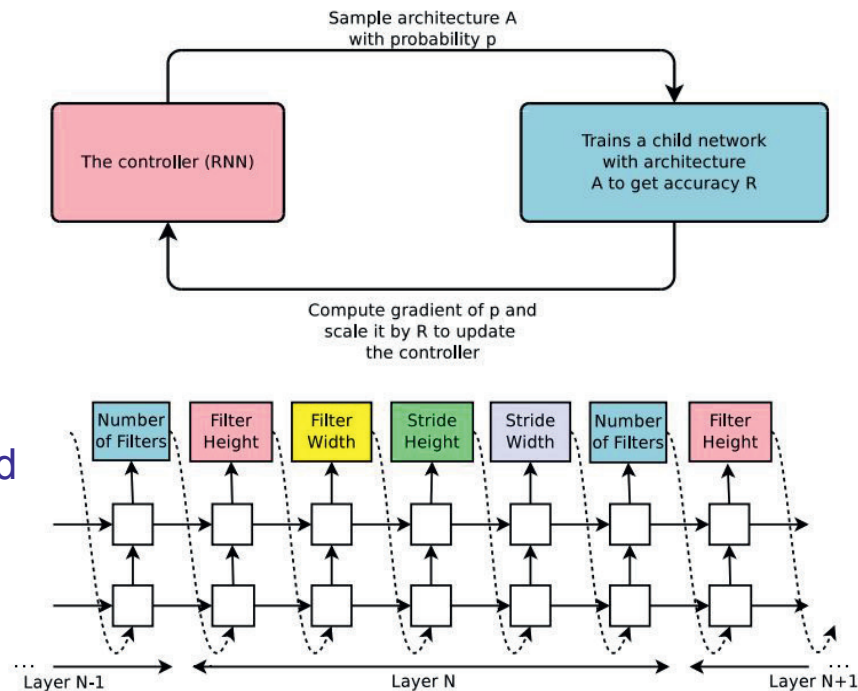

Learning to search for network architectures...

Learning Transferable Architectures for Scalable Image Recognition

[Zoph et al. 2017]

- Applying neural architecture search (NAS) to a large dataset like ImageNet is expensive
- Design a search space of building blocks (“cells”) that can be flexibly stacked
- NASNet: Use NAS to find best cell structure on smaller CIFAR-10 dataset, then transfer architecture to ImageNet
- Many follow-up works in this space e.g. AmoebaNet (Real et al. 2019) and ENAS (Pham, Guan et al. 2018)

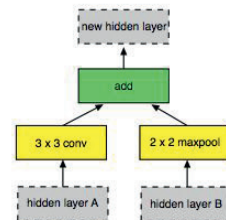
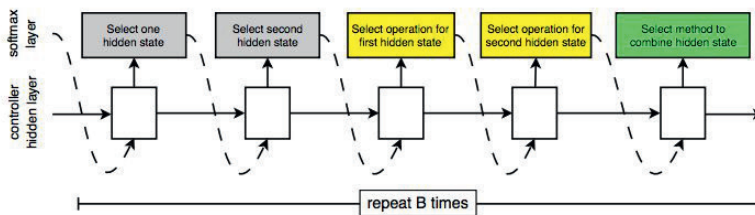
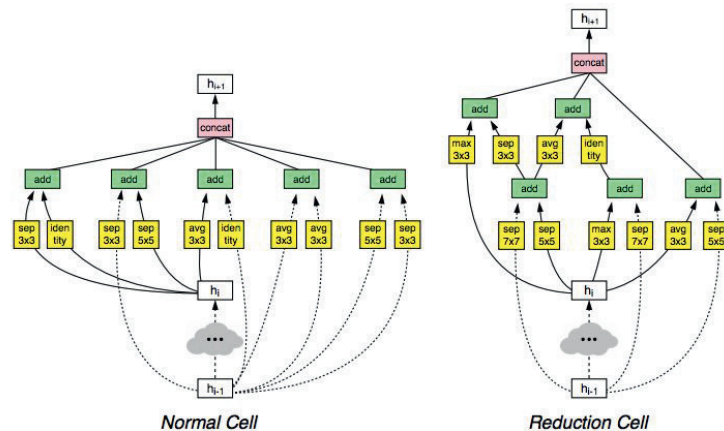

But sometimes smart heuristic is better than NAS ...

EfficientNet: Smart Compound Scaling

[Tan and Le. 2019]

- Increase network capacity by scaling width, depth, and resolution, while balancing accuracy and efficiency.
- Search for optimal set of compound scaling factors given a compute budget (target memory & flops).
- Scale up using smart heuristic rules

$$\text{depth: } d = \alpha^\phi$$

$$\text{width: } w = \beta^\phi$$

$$\text{resolution: } r = \gamma^\phi$$

$$\text{s.t. } \alpha \cdot \beta^2 \cdot \gamma^2 \approx 2$$

$$\alpha \geq 1, \beta \geq 1, \gamma \geq 1$$

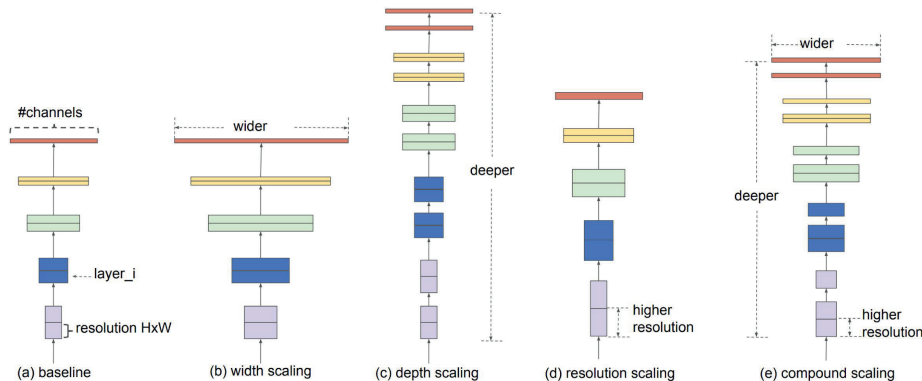
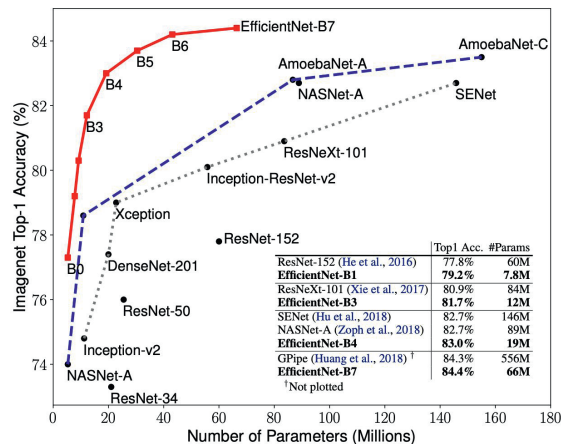

Summary: CNN Architectures

Case Studies

- AlexNet
- VGG
- GoogLeNet
- ResNet

Also....

- SENet
- Wide ResNet
- ResNeXT
- DenseNet
- MobileNets
- NASNet

Main takeaways

AlexNet showed that you can use CNNs to train Computer Vision models.

ZFNet, **VGG** shows that bigger networks work better

GoogLeNet is one of the first to focus on efficiency using 1x1 bottleneck convolutions and global avg pool instead of FC layers

ResNet showed us how to train extremely deep networks

- Limited only by GPU & memory!
- Showed diminishing returns as networks got bigger

After ResNet: CNNs were better than the human metric and focus shifted to Efficient networks:

- Lots of tiny networks aimed at mobile devices: **MobileNet**, **ShuffleNet**

Neural Architecture Search can now automate architecture design

Summary: CNN Architectures

- Many popular architectures available in model zoos
- ResNet and SENet currently good defaults to use
- Networks have gotten increasingly deep over time
- Many other aspects of network architectures are also continuously being investigated and improved

- Next time: Recurrent neural networks

Next time: Recurrent Neural Networks